

# Overview in Biofuels Research in Brazil

Marcos Buckeridge

Departamento de Botânica  
Instituto de Biociências – USP  
msbuck@usp.br

INCT  
BIOETANOL



# MOTIVATION TO DO RESEARCH AND USE BIOENERGY



EnergySecurity



Global ClimateChange

# BIOENERGY: what is it?

...renewable energy made available  
from materials derived from  
biological sources

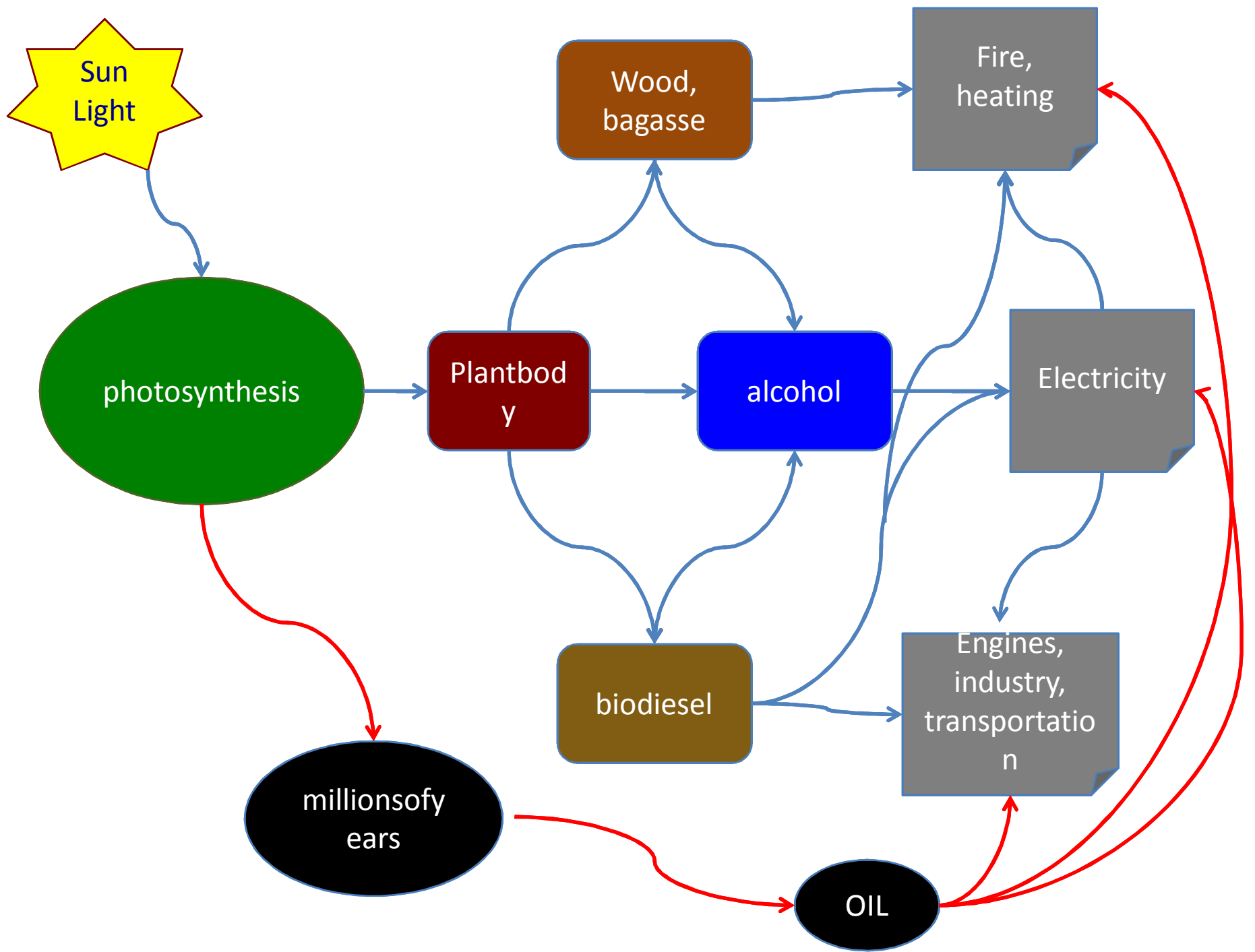

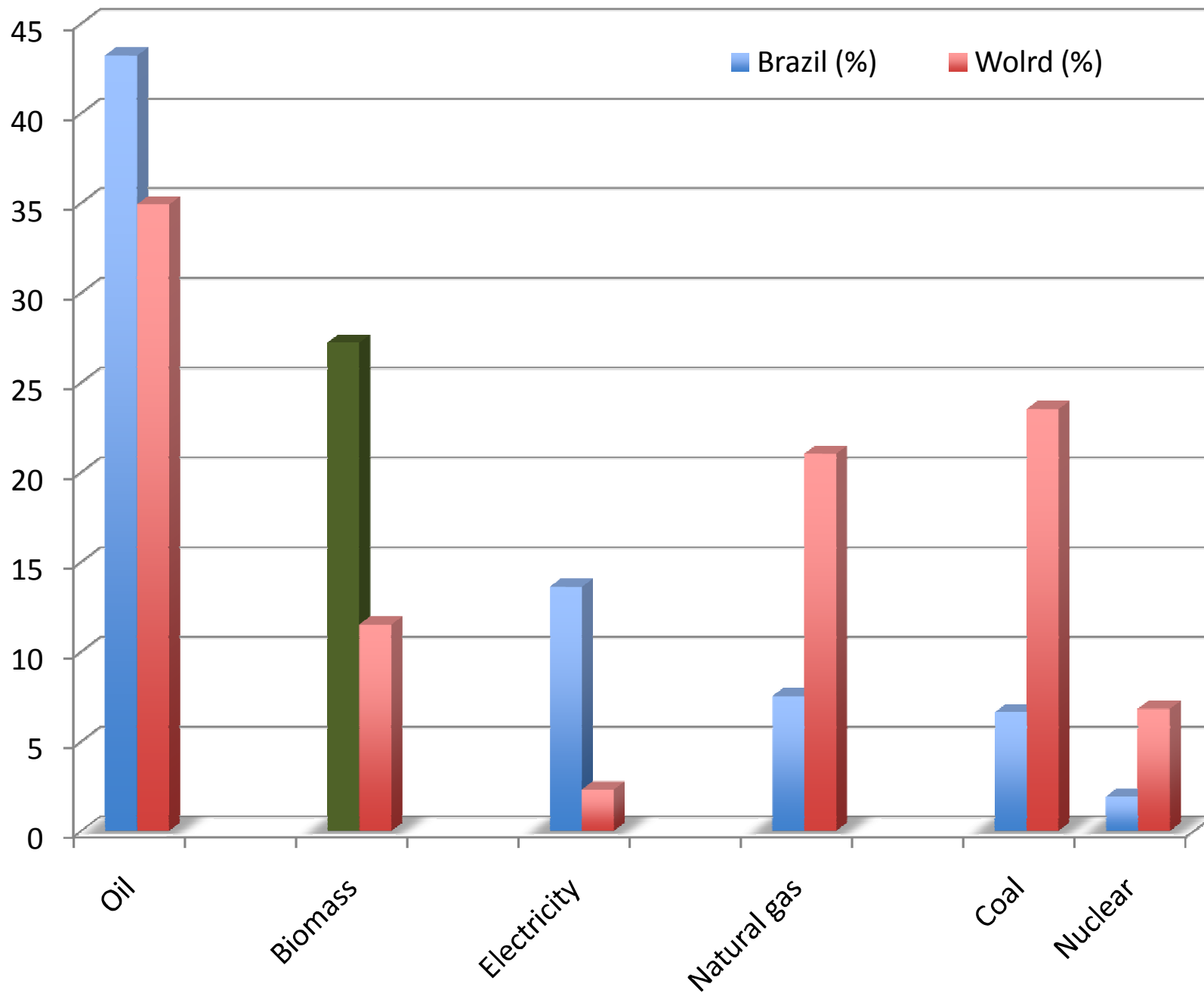

# Biodiesel in Brazil

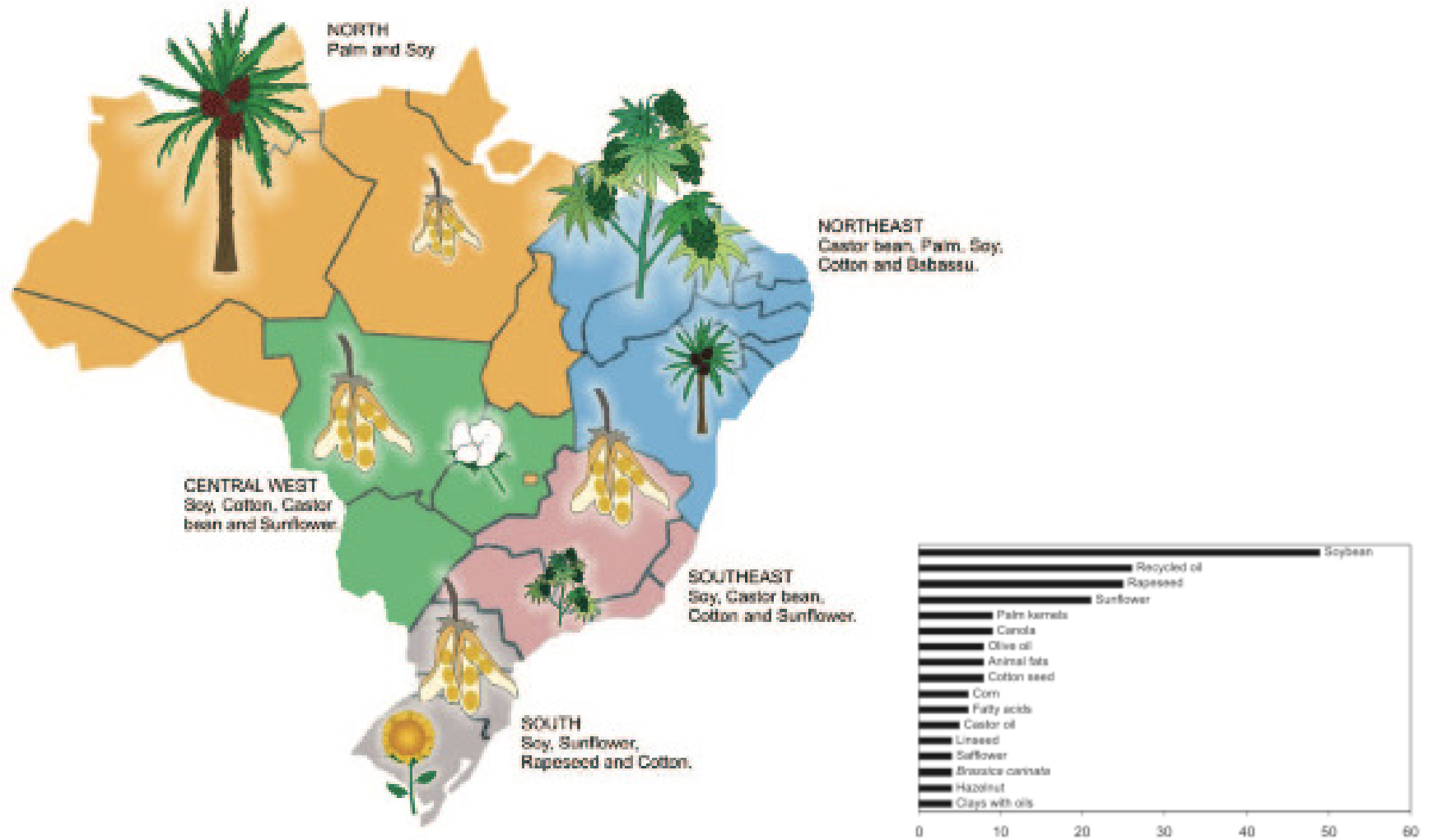

Figure 4. Leading biodiesel sources cited in scientific articles.



# SUGARCANE AND ETHANOL IN BRAZIL

INCT  
BIOETANOL



# Domestication and early evolution of sugarcane

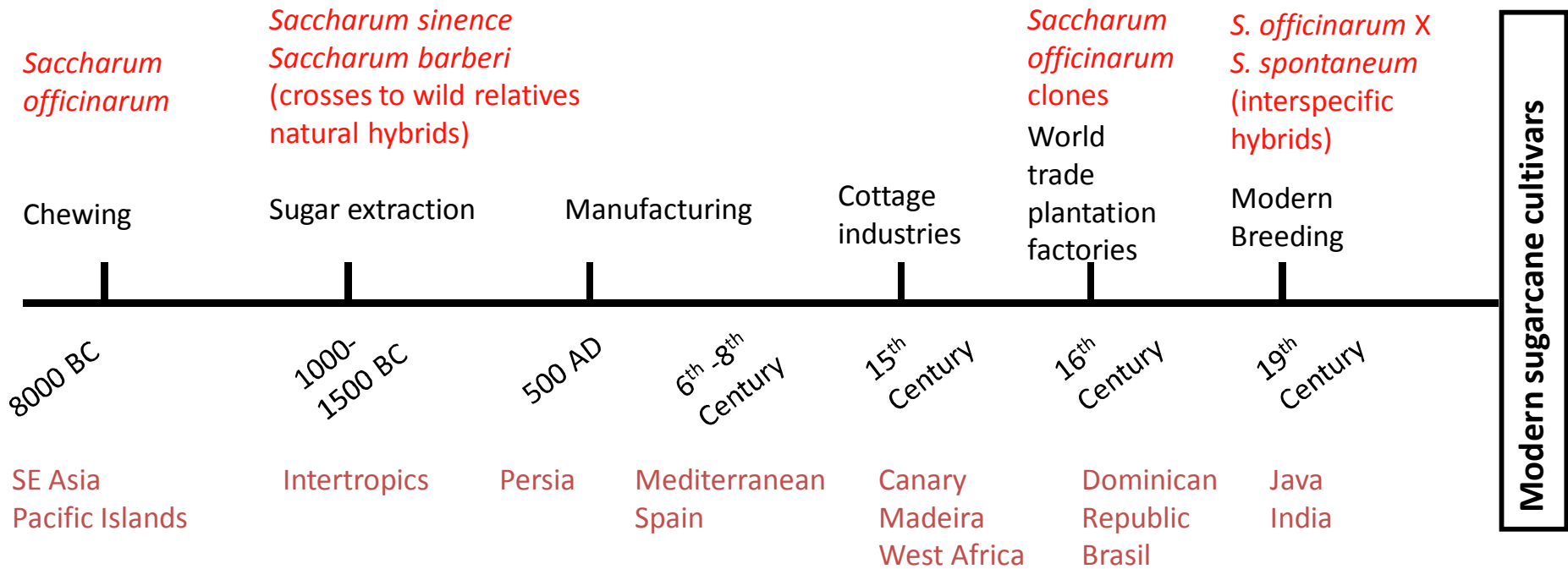

Modern sugarcane cultivars

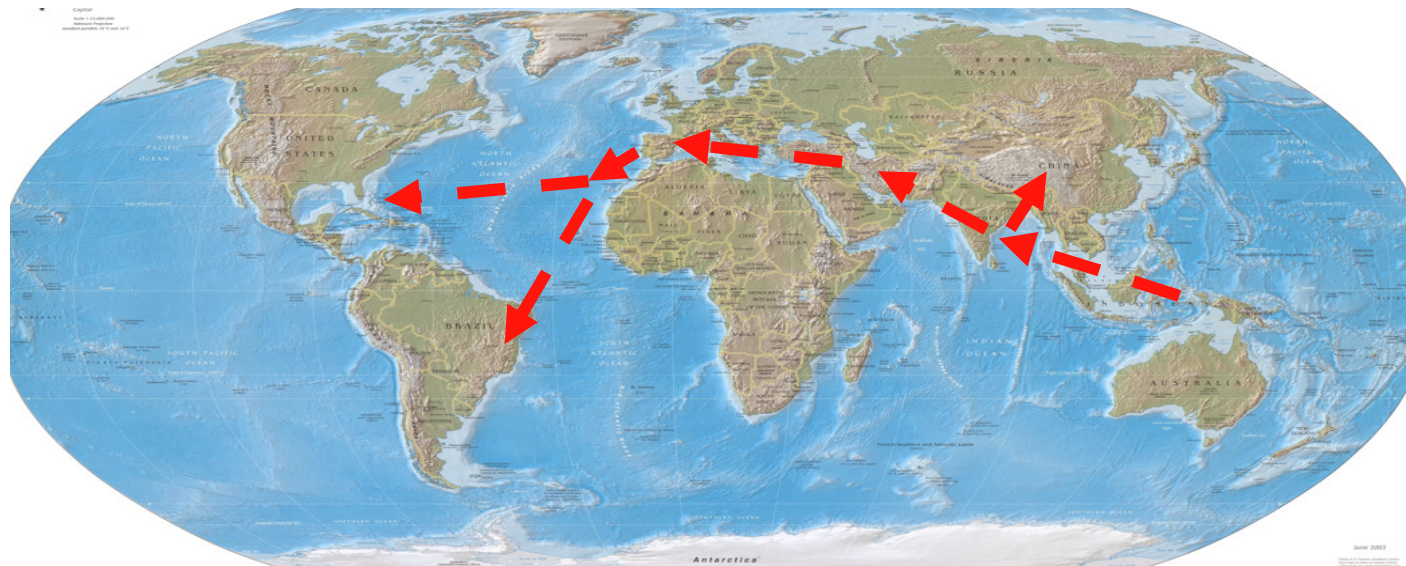



# The use of ethanol in Brazil started in the Northeast at the beginning of the 20th Century



Photography showing one of the tanks for ethanol storage as Usina Serra Grande (Source: Museu Carlos Lyra)

*In April 1933, there were ethanol pumps serving cars in several cities in the Northeast of Brazil: 3 in Recife; 1 in Caruaru, 1 in Garanhuns, 2 in Maceió, 1 in Serra Grande, 1 in União dos Palmares.*

# Cars selling of light vehicles in Brazil (1979-2007)

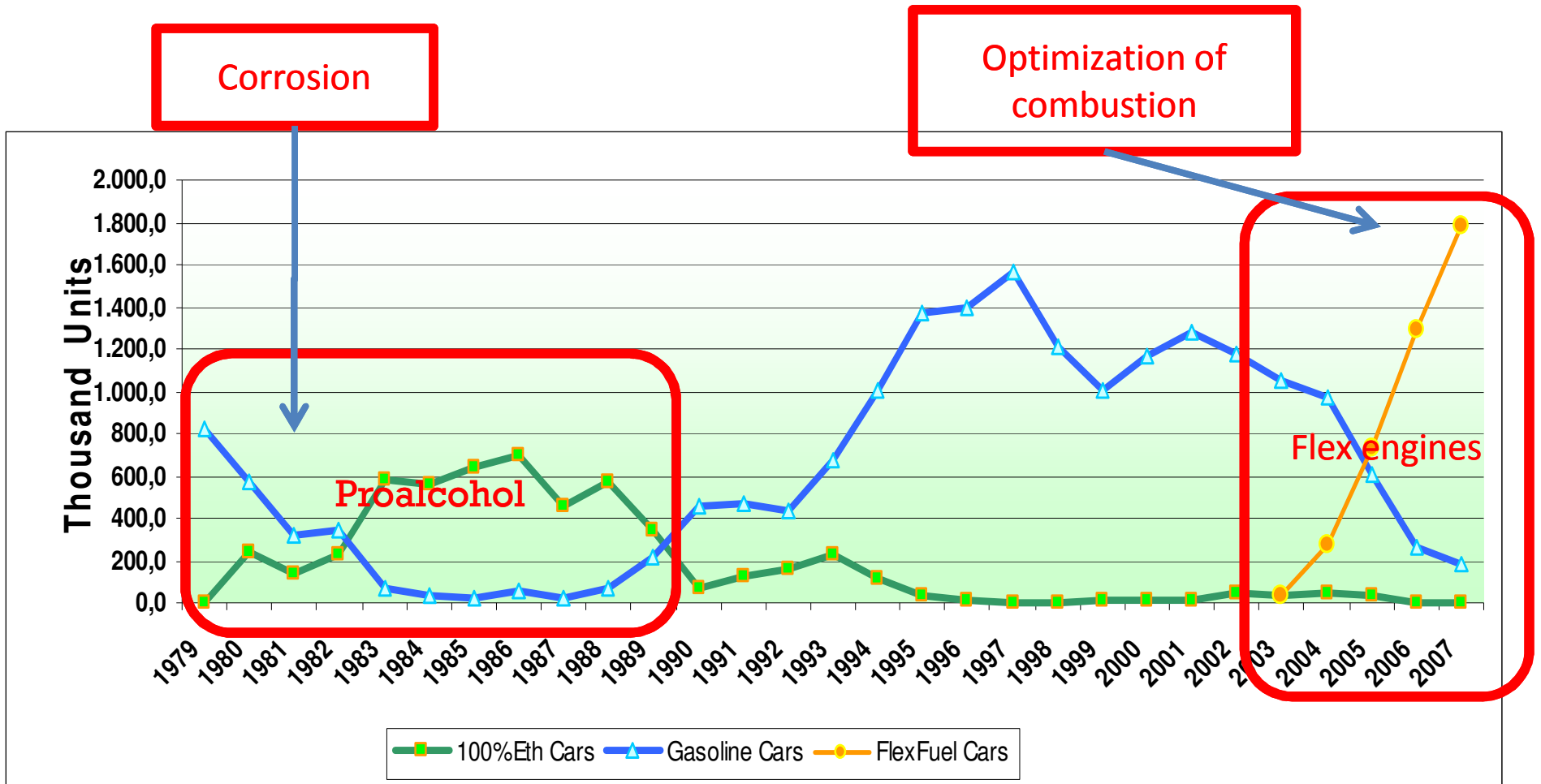



## FLOW DIAGRAM – SUGAR AND ETHANOL

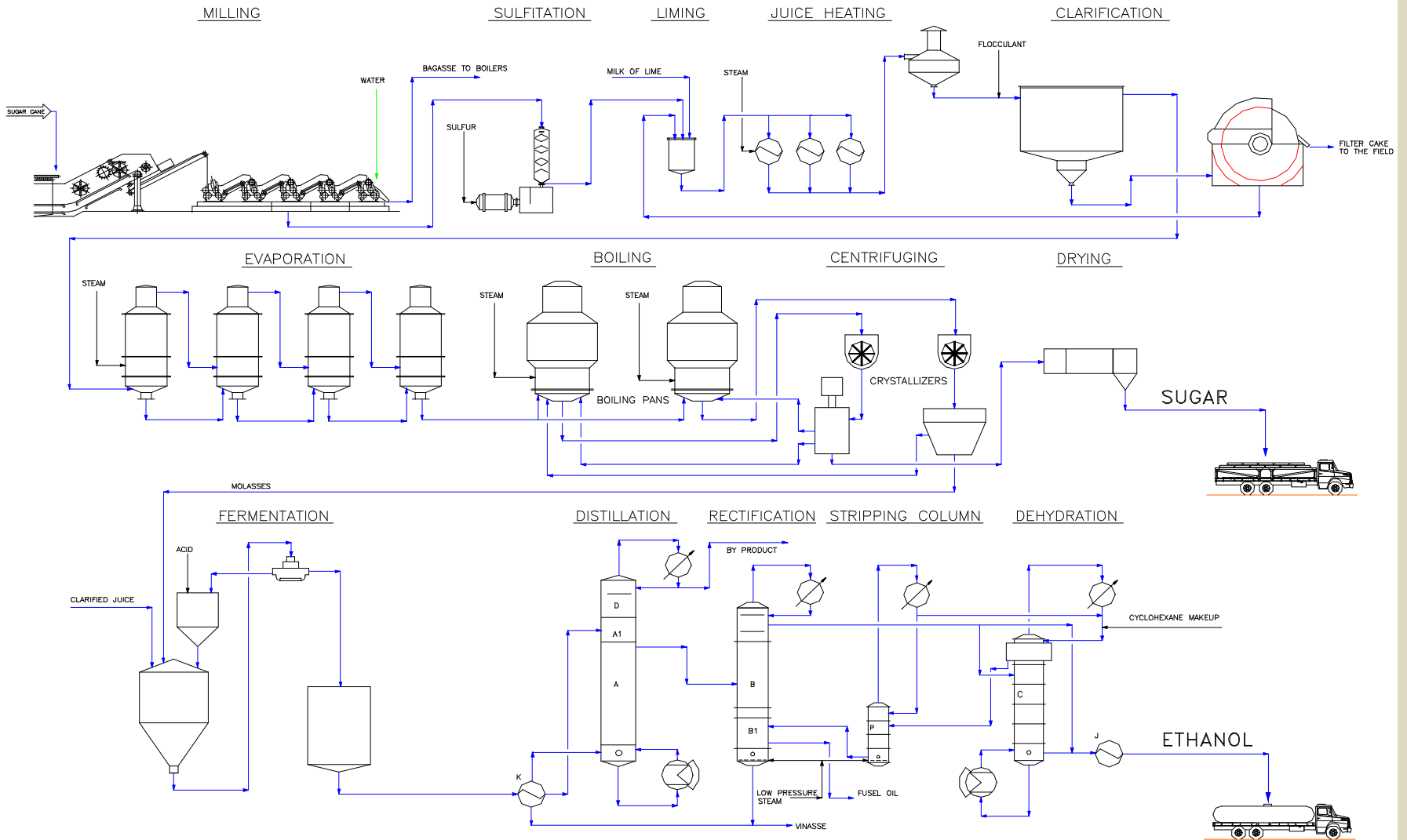

# INCT BIOETANOL

## ENERGY RESEARCH IN BRAZIL

CeProBIO

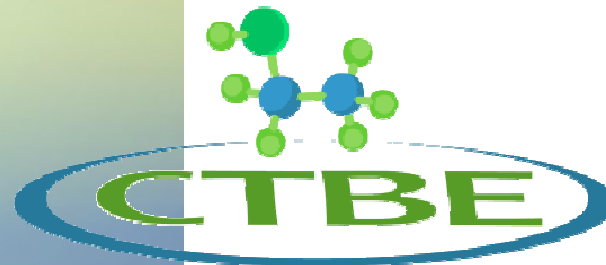

# A INTERNATIONAL RESEARCH NETWORK IS NOW BEING ASSEMBLED





INCT  
BIOETANOL

GENETICS OF  
CANE



## Selection Process

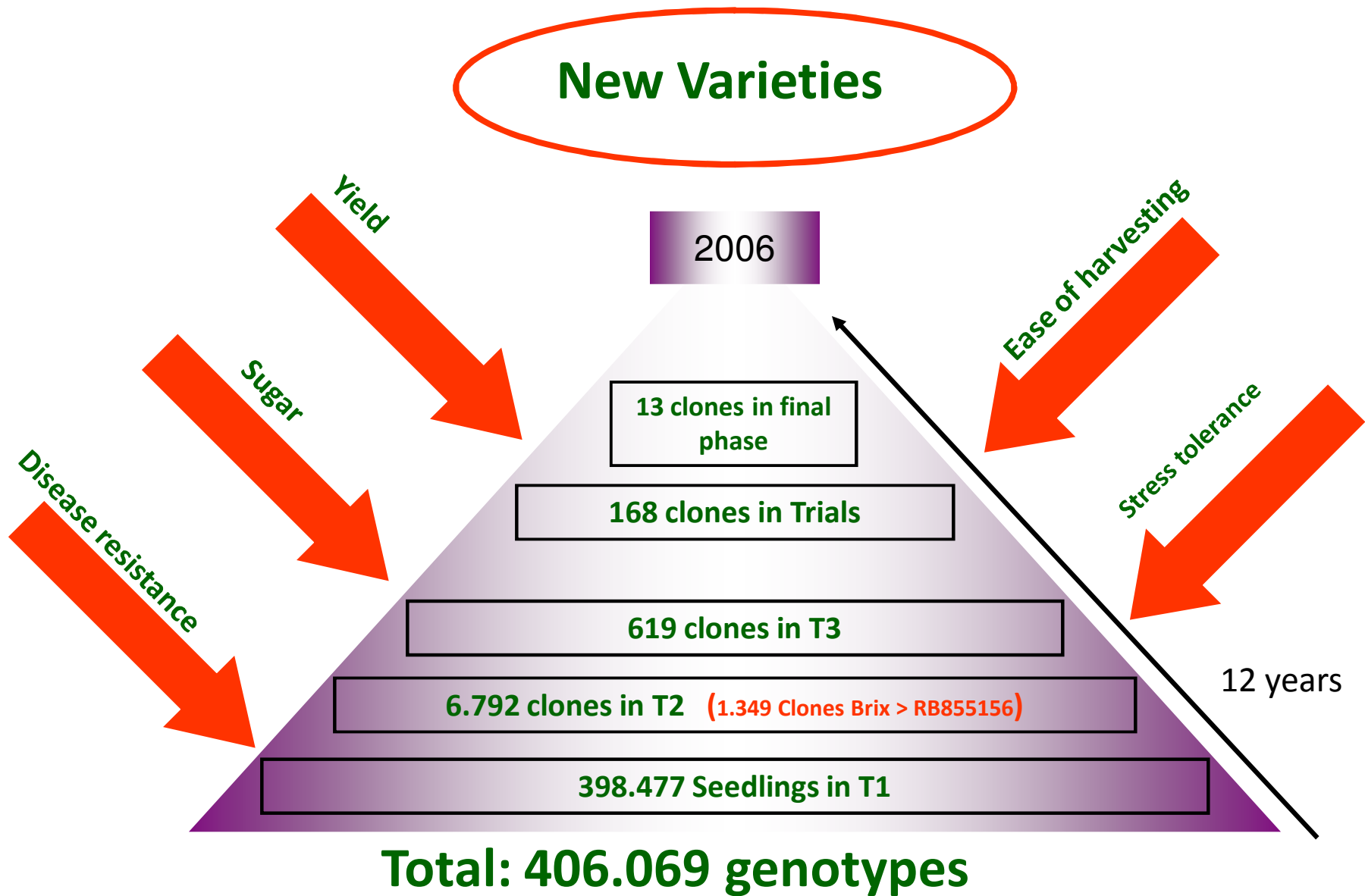



# Production of transgenic sugarcane plants CBTEC – Esalq

*Potential to shorten production of new varieties to 6 years*



Explants:  
Immature Leaves

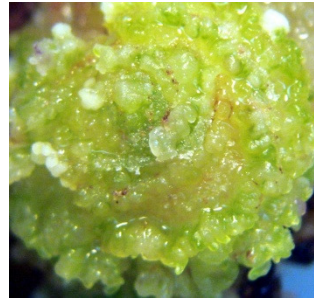

Callus  
Induction



Regeneration Selective  
Medium



Rooting

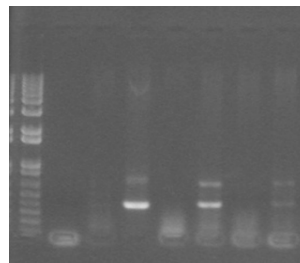

PCR

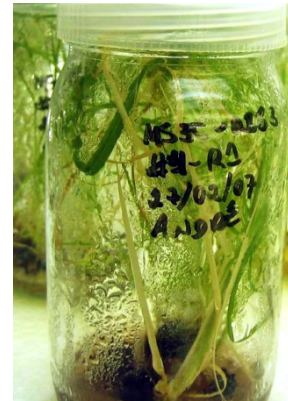

Shoot Growth



Greenhouse



INCT  
BIOETANOL

*AGRIBUSINESS*



## Cost versus production of ethanol in Brazil

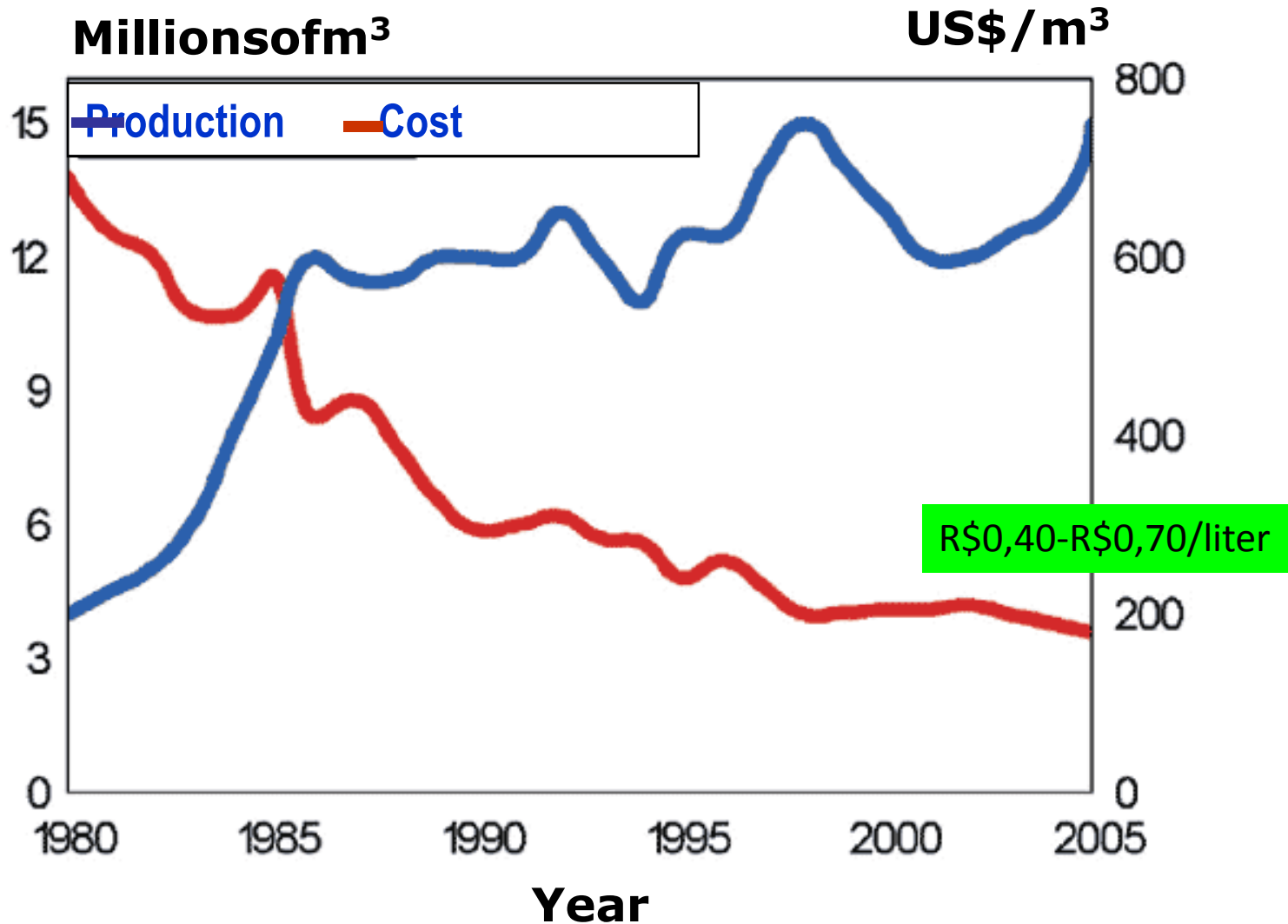

<http://www.biodieselbr.com/energia/alcool/etanol.htm>

# Potential of different areas for production of sugarcane in Brazil based on soil and climate without irrigation

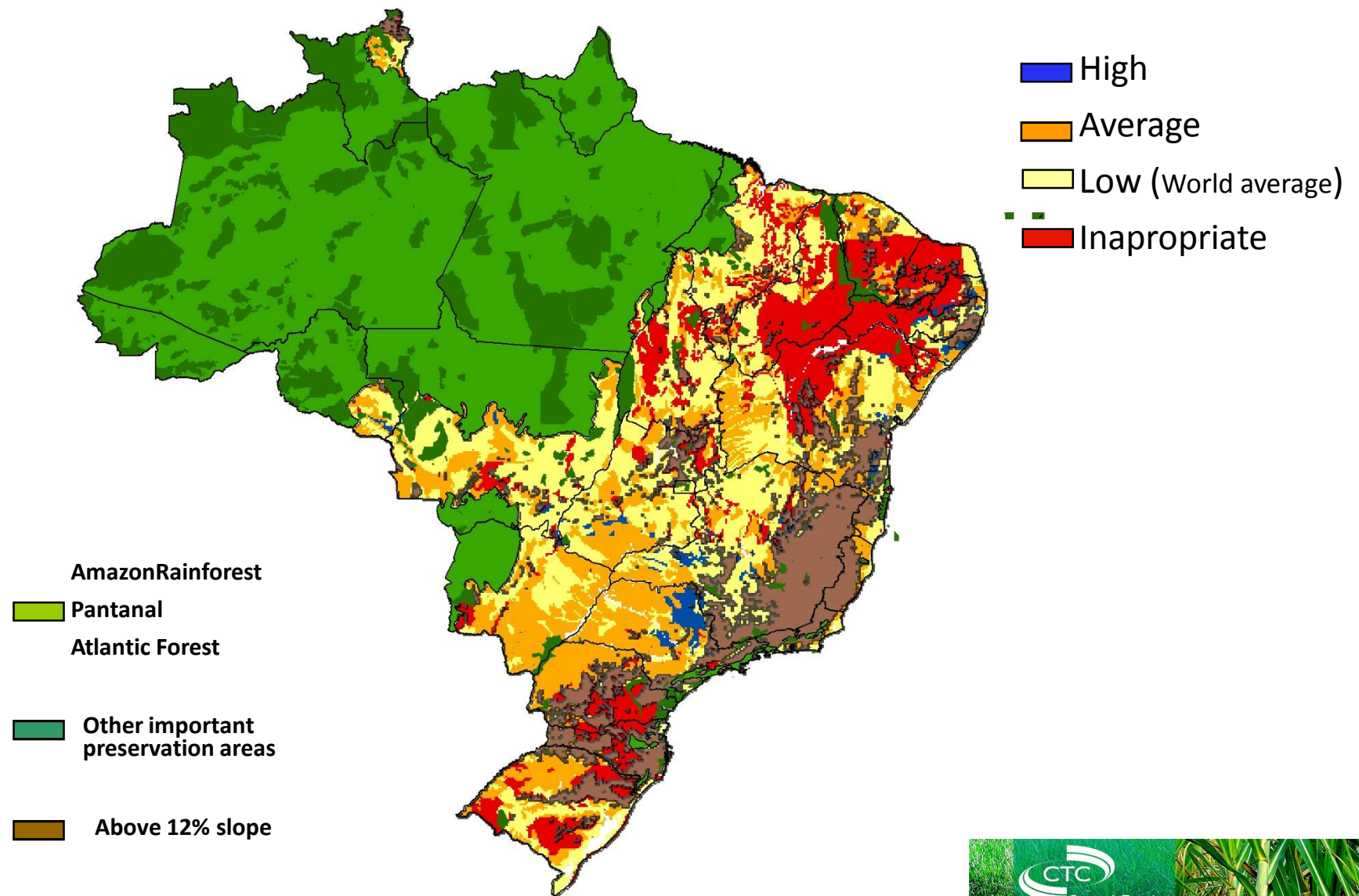

# Current mechanization



# Controlled Traffic Structure (CTS): to be used for precision agriculture

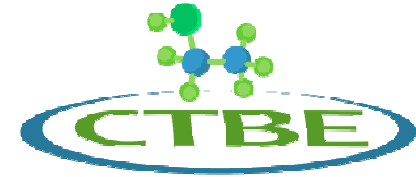

# INCT BIOETANOL

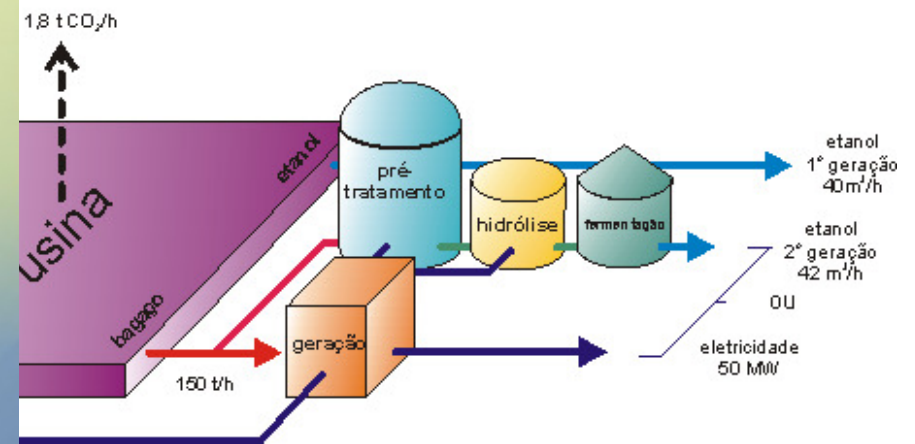

Using the CO<sub>2</sub> produced during the process to empower algae to make biodiesel could be a great help to decrease CO<sub>2</sub> emissions

Modified from Paulo Selegim, lab leader at the INCT Bioethanol



INCT  
BIOETANOL

1<sup>ST</sup> STEP:  
ETHANOL





## Targets in processing research

---

Study different types of pretreatments and perform experiments in pilot scale at the pilot plant of CTBE

Performance, energy balances, economical viability, environmental sustainability

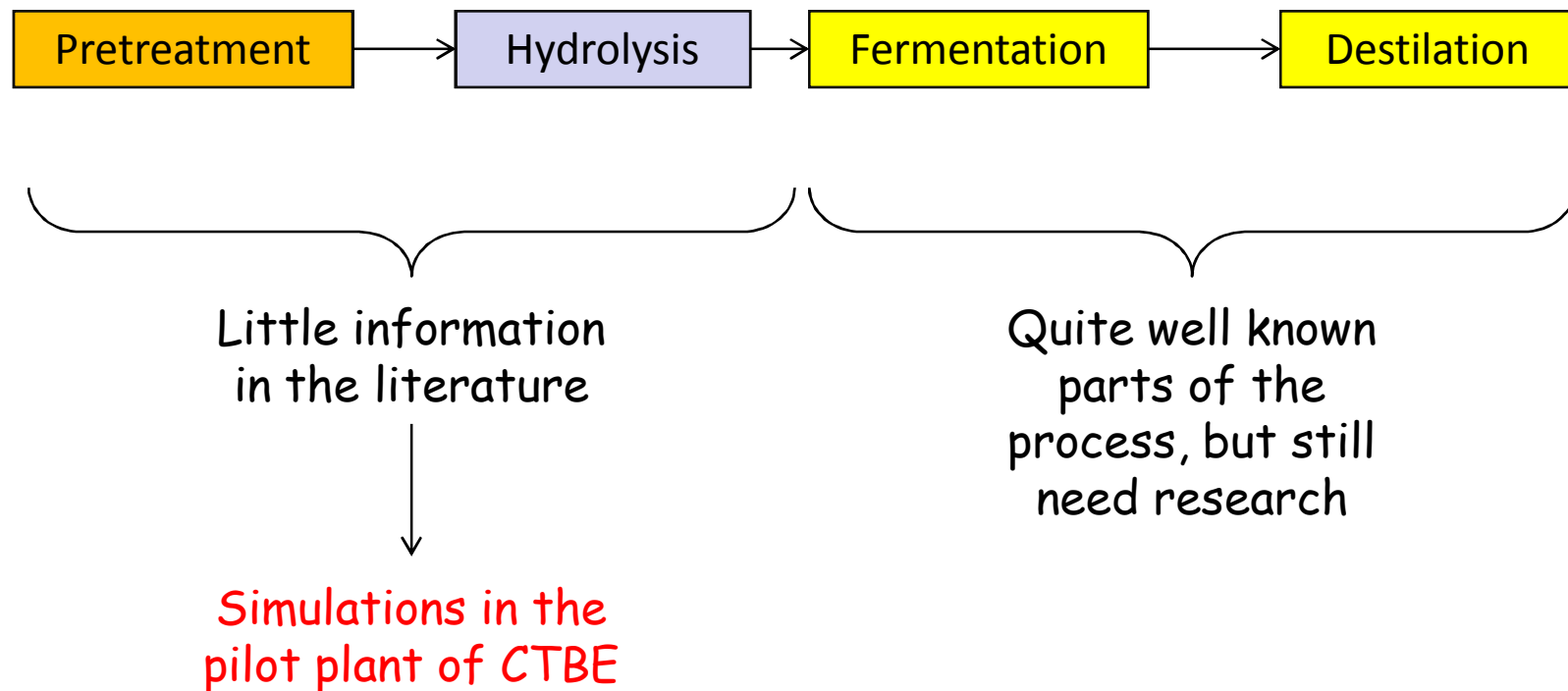

Making bagass to “POP” as popcorn does!



## Targets in processing research

Benchequipment to perform experiments of steam explosion ( $< 5 \text{ kg/h}$ )

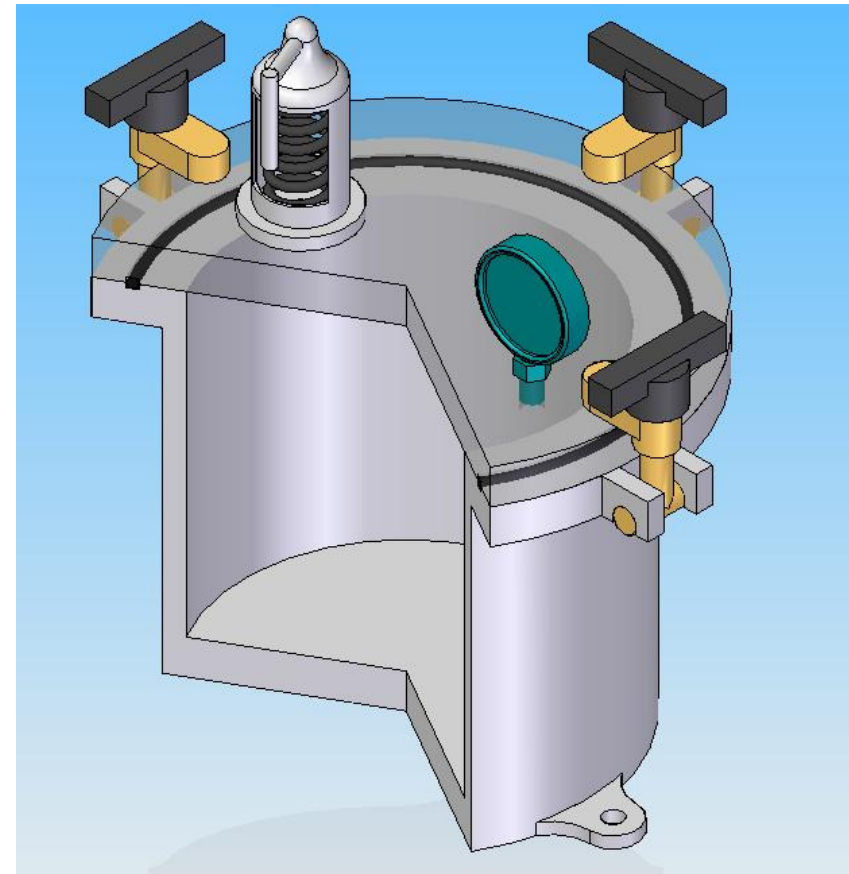
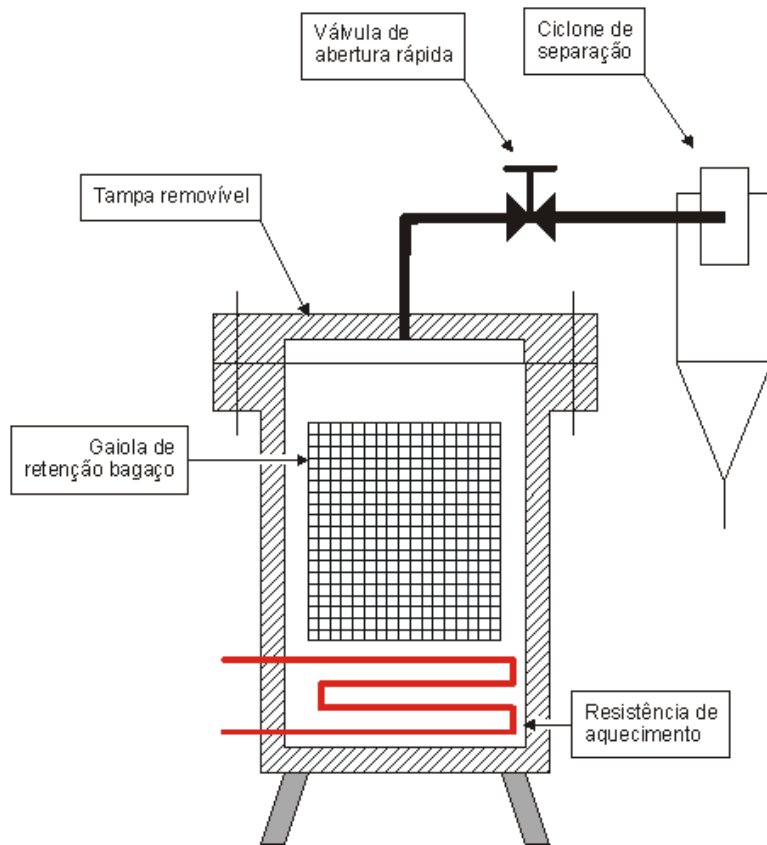

Courtesy of Paulo Selegim, lab leader at the INCT Bioethanol



# Primary energy in sugarcane

(fibers are 2/3 of the energy)

<b>Component</b>	<b>MJ/tc</b>
150 kgsugars	2.500
135 kgfiber in culms	2.400
140 kgfiber in leaves	2.500
<b>Total</b>	<b>7.400</b>

Notas:

1. tc: tons of culm
2. Fiber dry weight



Calculated by Carlos Rossel

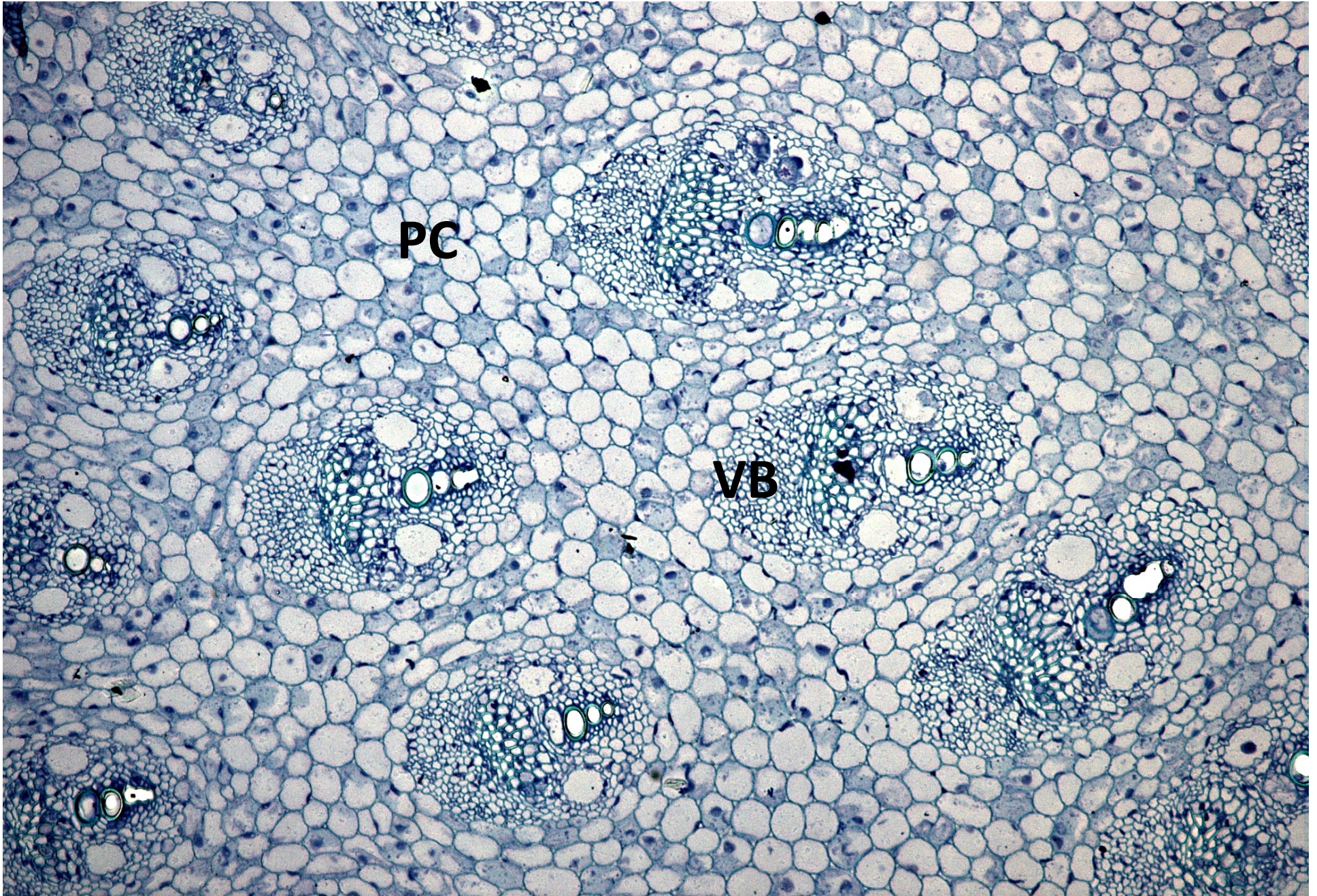

CULM OF SUGARCANE

# After processing, different fractions have distinct textures

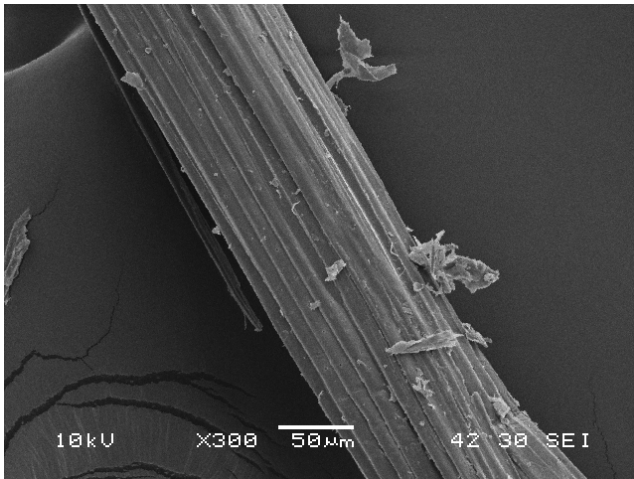

Fiber

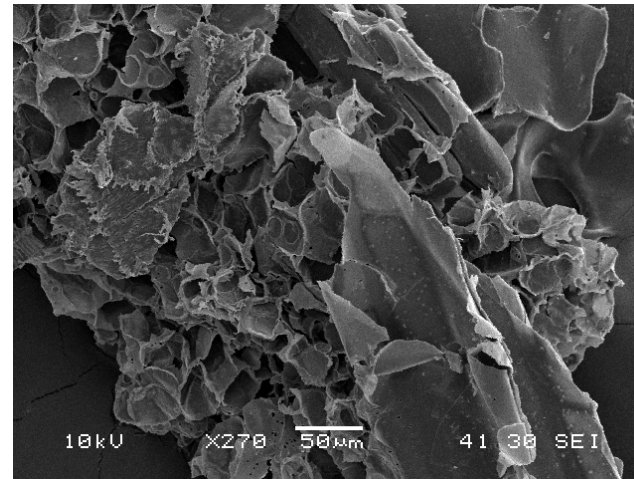

Parenchyma

# The challenge of cellulosic ethanol: How to modify the wall to obtain energy and other valuable products?

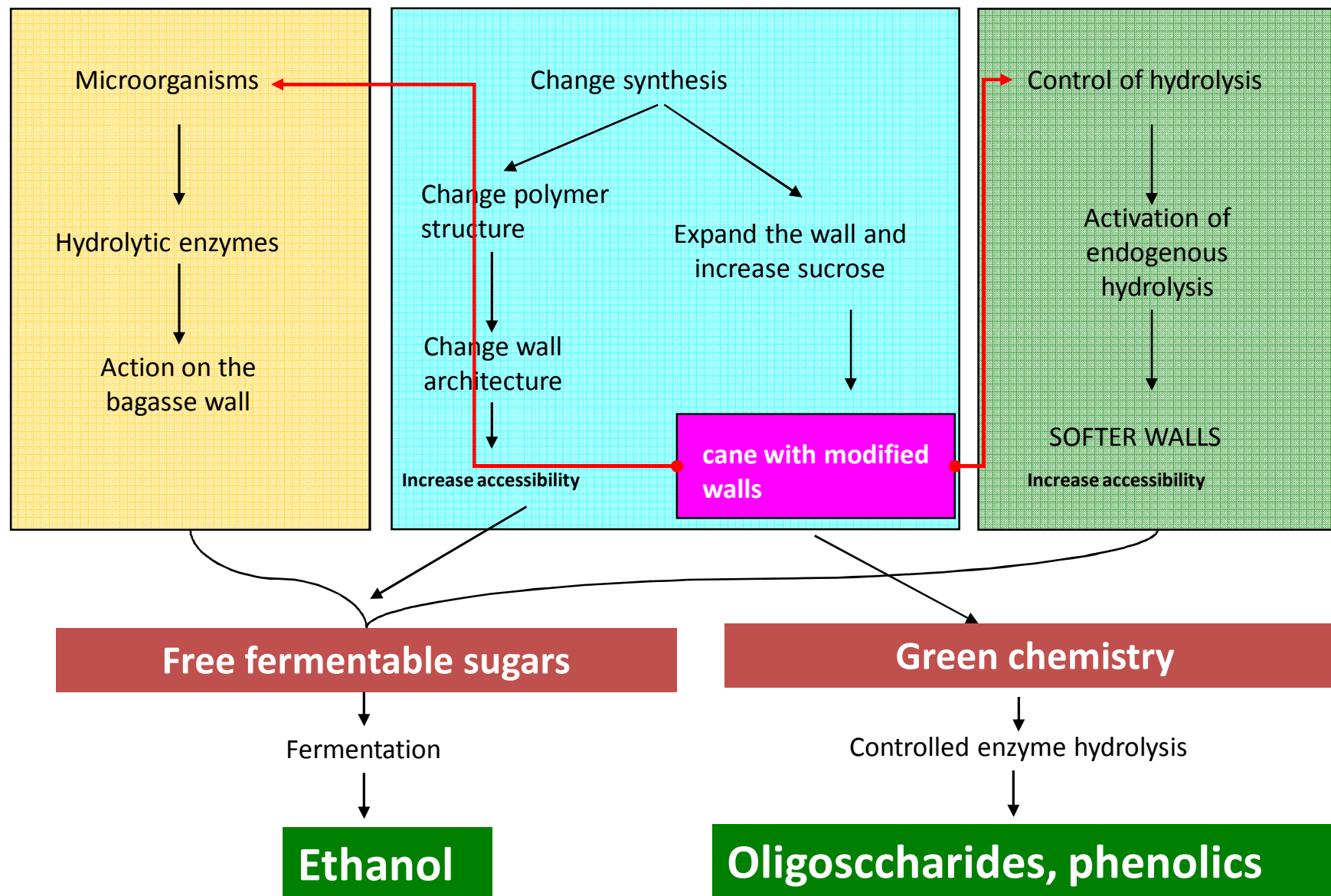



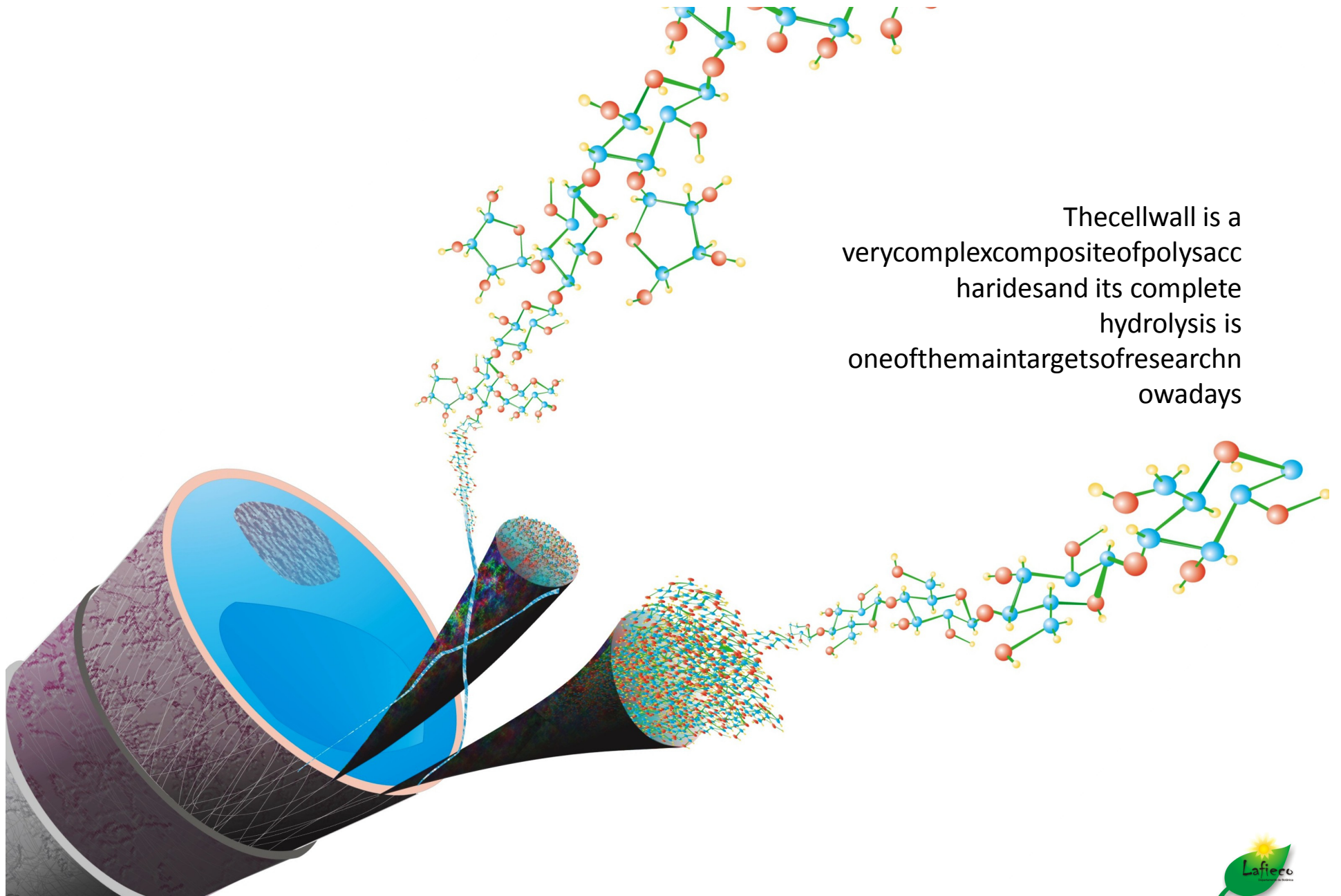

The cell wall is a very complex composite of polysaccharides and its complete hydrolysis is one of the main targets of research nowadays

# Interdisciplinary approaches are needed at all levels

Biodiversity



Molecular studies

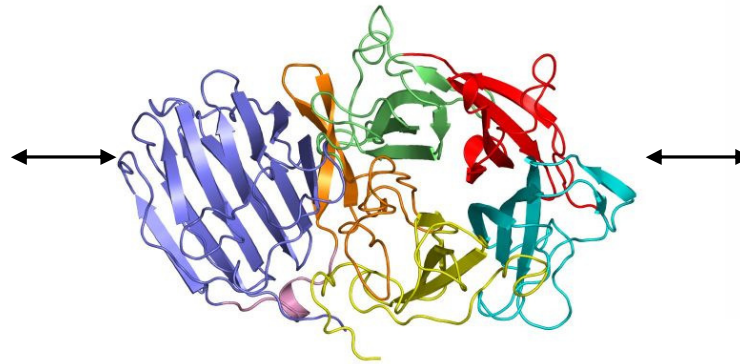

Enzymology

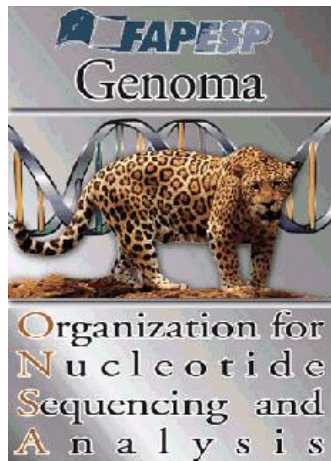
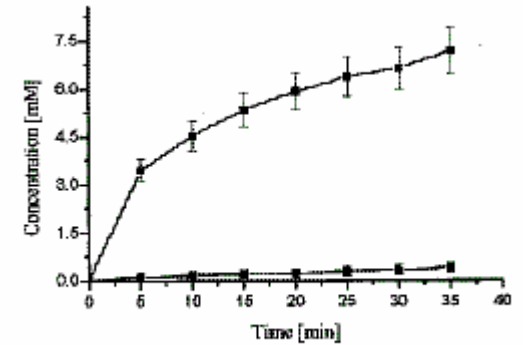

Genomics

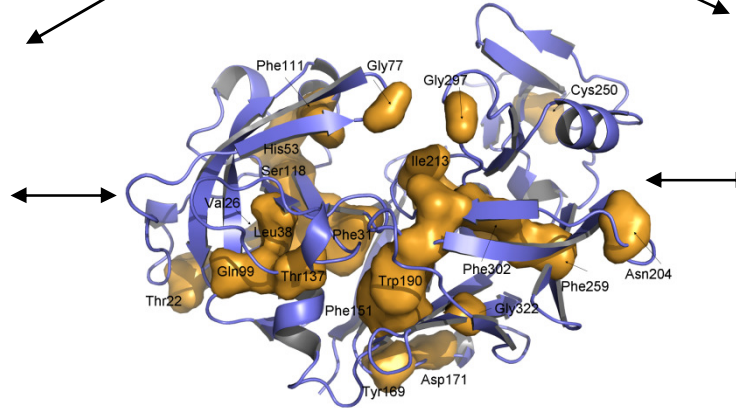
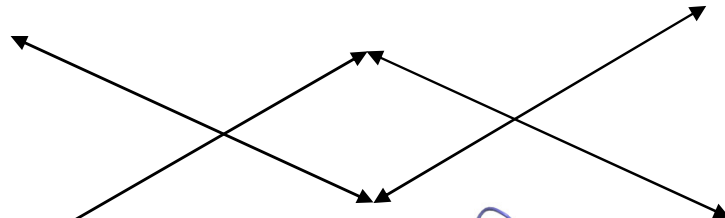

Bioinformatics and  
Systems Biology



Industrial process



environment



For Brazil, sugarcane is the best way to obtain renewable liquid fuels

But how is it going to respond to the Global Climatic Changes?



Sugarcane leaves:  
CO<sub>2</sub> enters at both sides

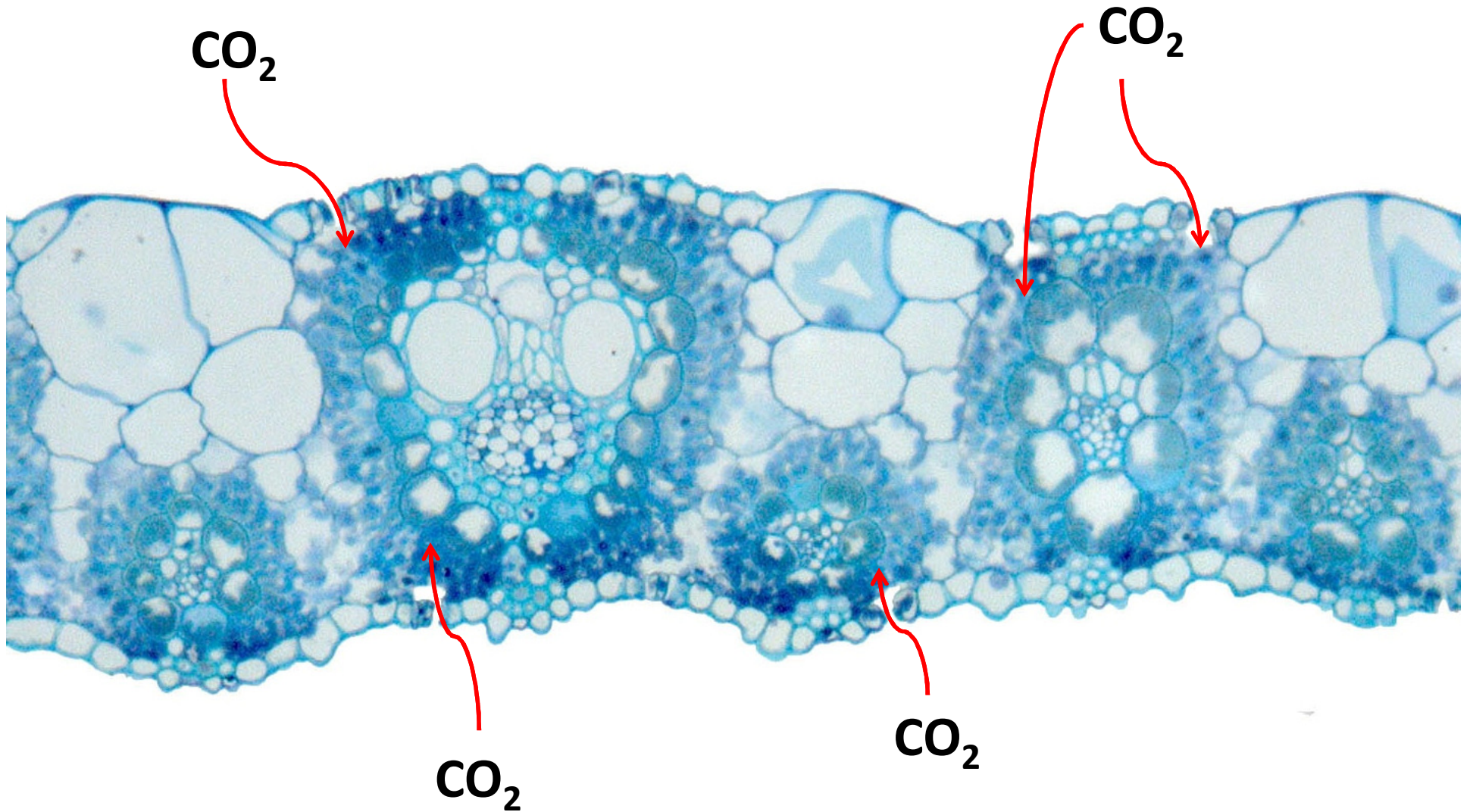

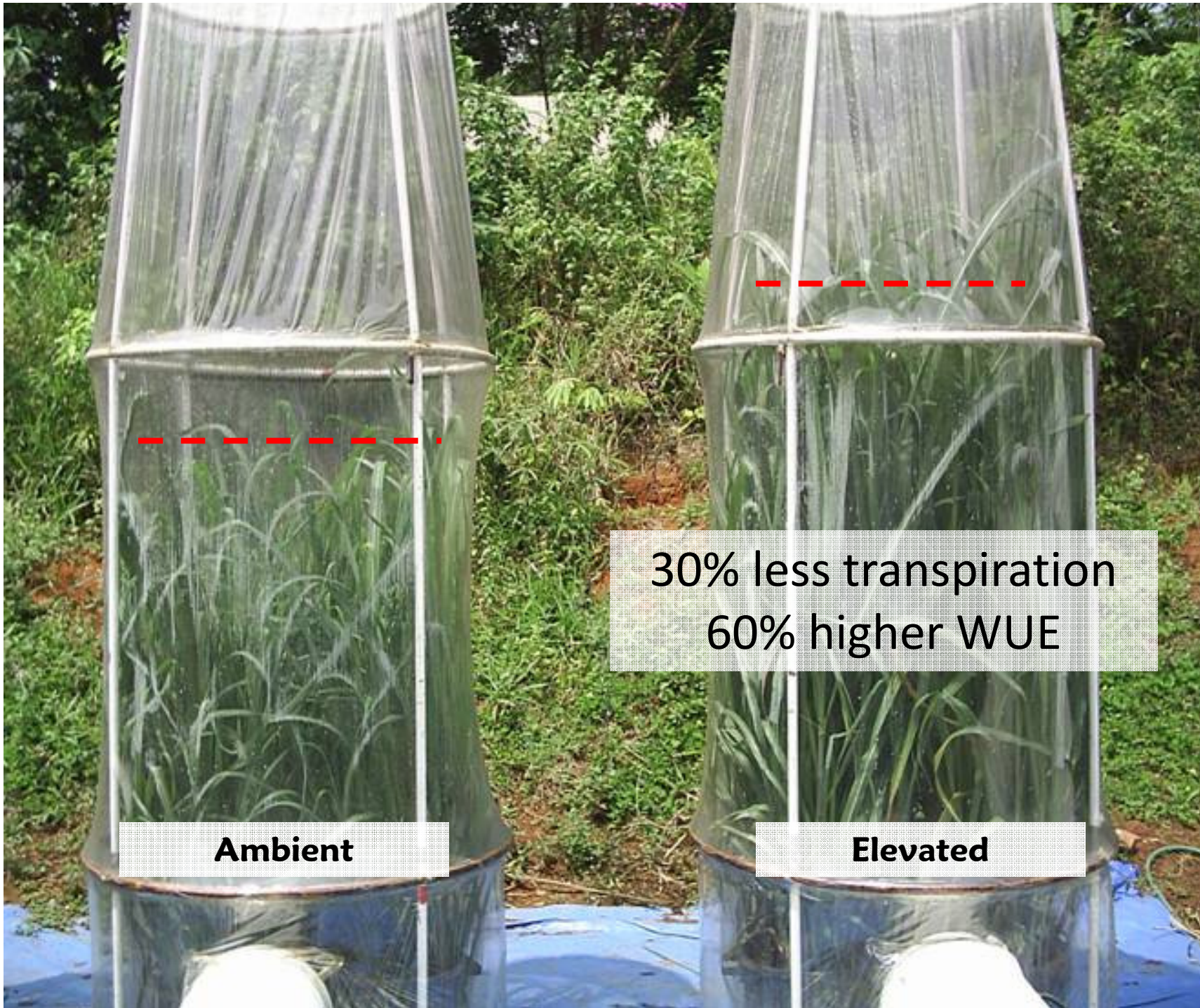

**Ambient**

30% less transpiration  
60% higher WUE

**Elevated**

Current CO<sub>2</sub>

Elevated CO<sub>2</sub>

60% more

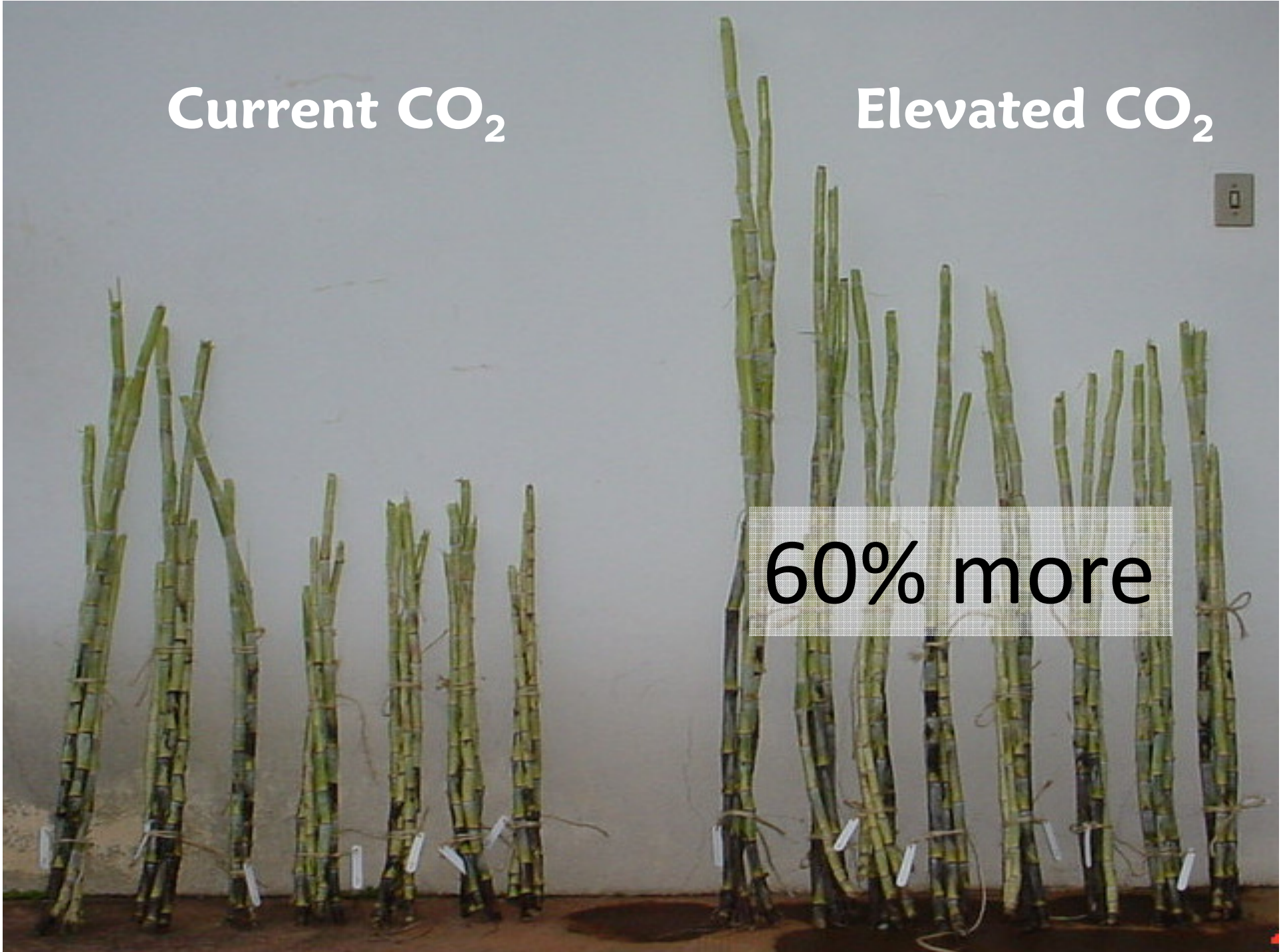



INCT  
BIOETANOL

Biofuels  
water use





# THE MIDWAY

“O caminho do meio”

- 1) Increase in cane productivity
- 2) Regeneration of forests and cerrado



Environmental  
Friendly Ethanol

Cane alone  
*Only biofuel production*

Cane with forest corridors  
*More ethanol production*  
*More C sequestration, plus ecosystem servi*

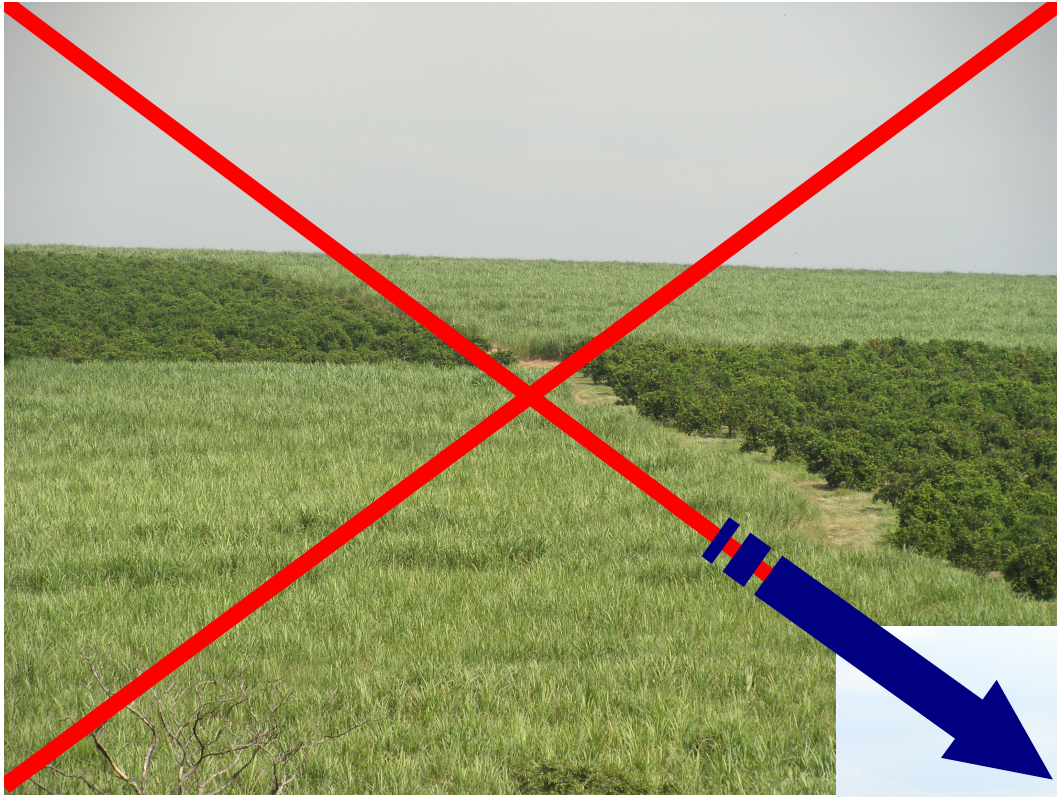

*Caminho do Meio*





marks

