

**PRODUCING QUALITY
FEEDSTOCK
FOR
BIODIESEL**

by

**Robert L. Stroup
R. L. STROUP CO. LTD**

INTRODUCTION

R.L. STROUP CO. LTD.



R.L. STROUP CO. LTD.



PIONEER[®]
BRAND · PRODUCTS

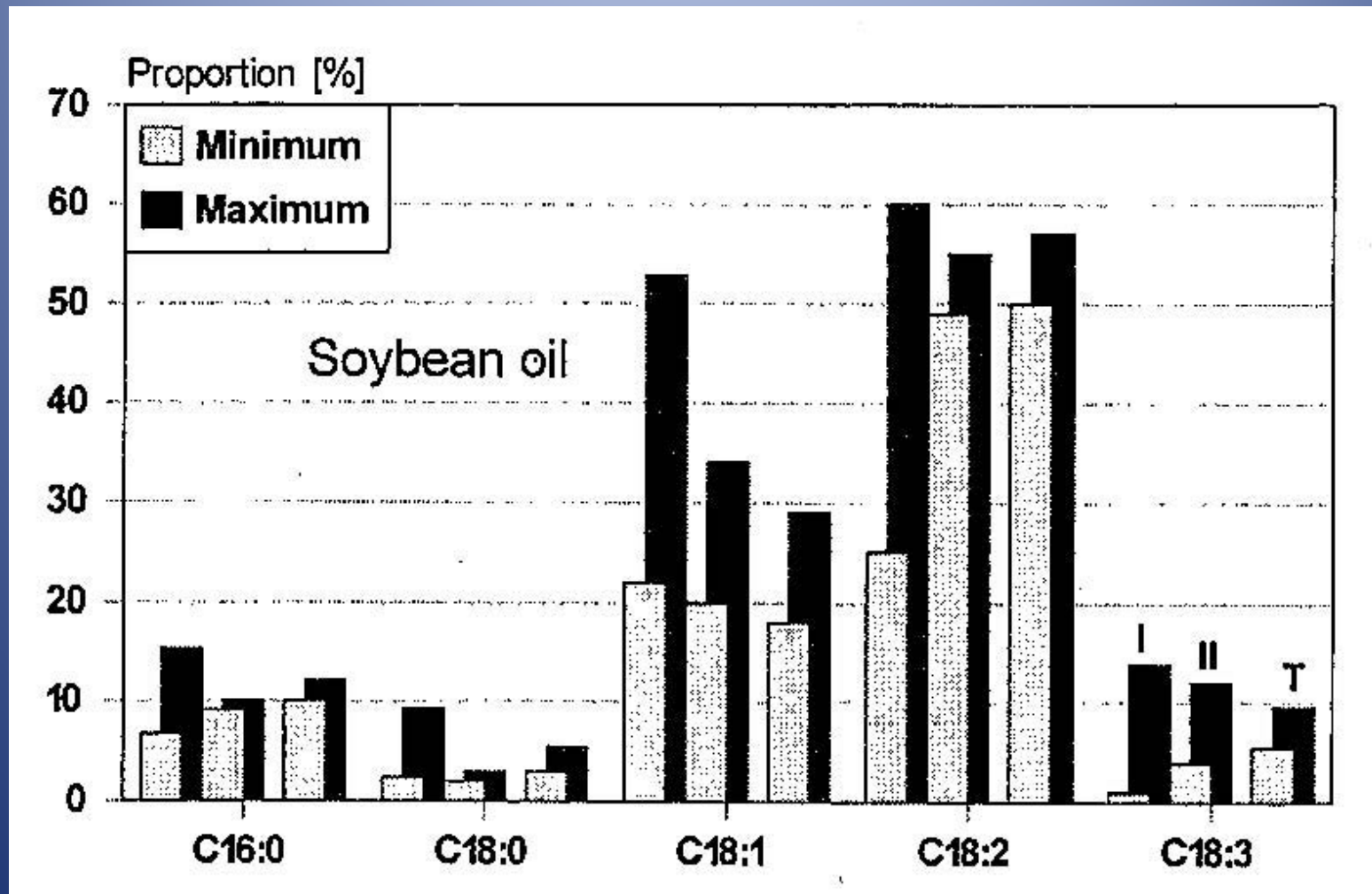
93M70



Fatty Acids

- The building blocks of fats & oils are the atoms of Carbon (C), Hydrogen (H) and Oxygen (O).
- Oil is a mixture of 96% to 98% tri-acylglycerols also known as triglycerides.
- Fatty Acids are the building blocks of tri-glycerides. they generally are 4 to 22 carbon atoms long for the purpose of discussing biodiesel.
- Fatty acids for BD are usually 16 and 18 carbons long with between 0 to 3 double bonds

GRAPH 01—Composition of Soybean Oil



Composition of Soybean Oil

The primary fatty acids are:

- C16:0—Palmitic Acid
- C18:0—Stearic Acid
- C18.1—Oleic Acid
- C18.2---Linoleic Acid
- C18:3---Linolenic Acid

Oilseed Crushing

- **Mechanical Extraction or Screw Pressing**
- **Solvent Extraction using a solvent such as hexane to remove the oil.**

Selection of Mechanical vs. Solvent Extraction Process:

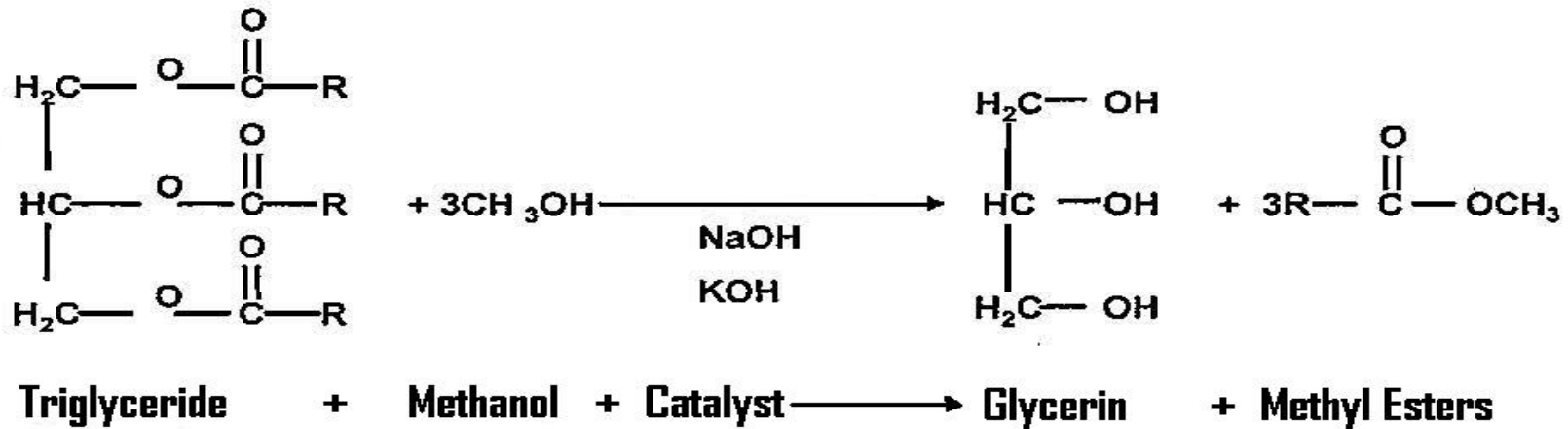
- Amount of seed to be crushed per day
- > 1000 MTPD favors Solvent Extraction
- Residual oil (RO) content in the meal
- Solvent Extraction yields +/- 0.06 RO
- Mechanical Extraction (ME) yields +/- 5.0%
- ME easy to expand by adding screw press lines

Transesterification

- In the transesterification process a triglyceride (oil or fat) is reacted with an alcohol, usually methanol. (in Brazil ethanol is often used because of lower price compared with the United States) in the presence of a base catalyst, such as sodium hydroxide.

TRANSESTERIFICATION REACTION

Transesterification Reaction



Ethanol vs. Methanol

- Ethanol is more expensive in the U.S. compared to Brazil.
- 143% more ethanol required for Transesterification
- Methanol is rated as one of the 168 high-toxic Substances by the USEPA

Basic Technology

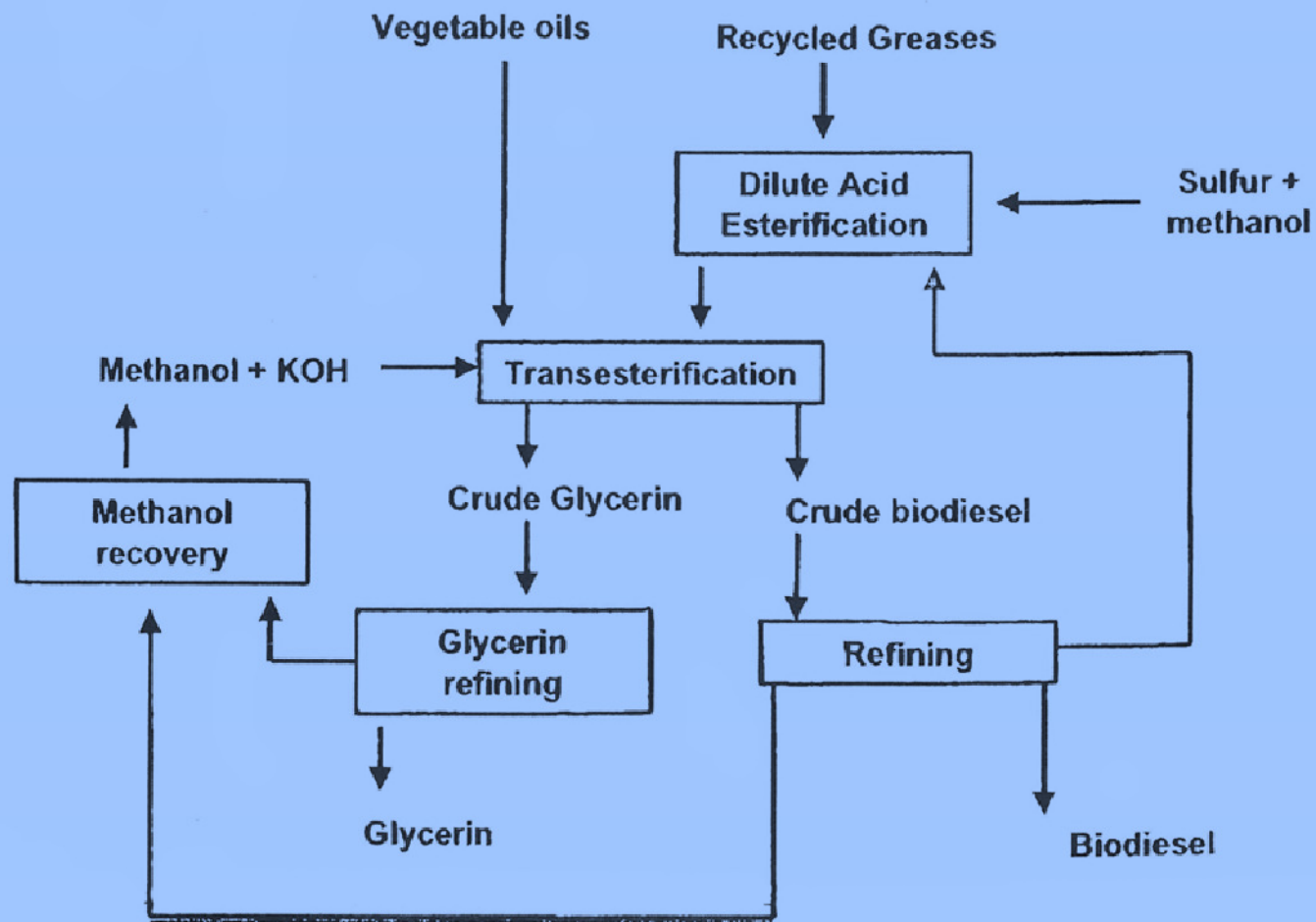


TABLE 1 - MASS BALANCE for BIODIESEL TRANESTERIFICATION

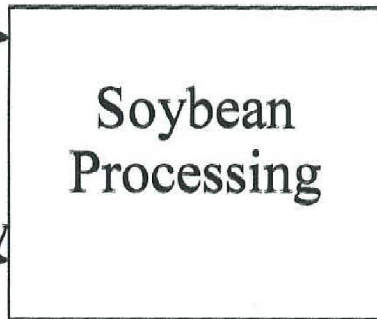
INPUTS / OUTPUTS	Kilograms
INPUTS	
Refined, Bleached Oil	1,002.0
Methanol	110.0*
Sodium Methoxide @ 100%	5.5
Citric Acid @ 50%	1.4
Hydrochloric Acid @ 36%	8.0
Caustic Soda @ 50%	0.75
Water	20.0
Input Total	1,147.0
OUTPUTS	
Biodiesel	1,000.0
Glycerin, water and MONG**	135.0
Fatty Acids	12.3
Output Total	1,147.0

SOYBEAN PROCESSING AND BIODIESEL PLANT FLOW DIAGRAM

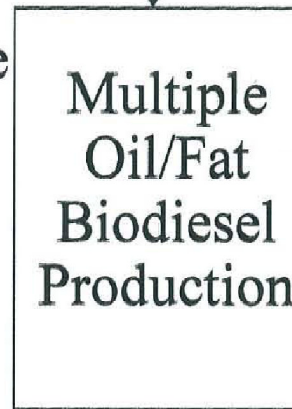
Alternative Oil or
Fat Feedstocks

Specialty
Soybean

Commodity
Soybean



Soy Crude
Oil



Edible Oil (Soy)

Lecithin

Biodiesel

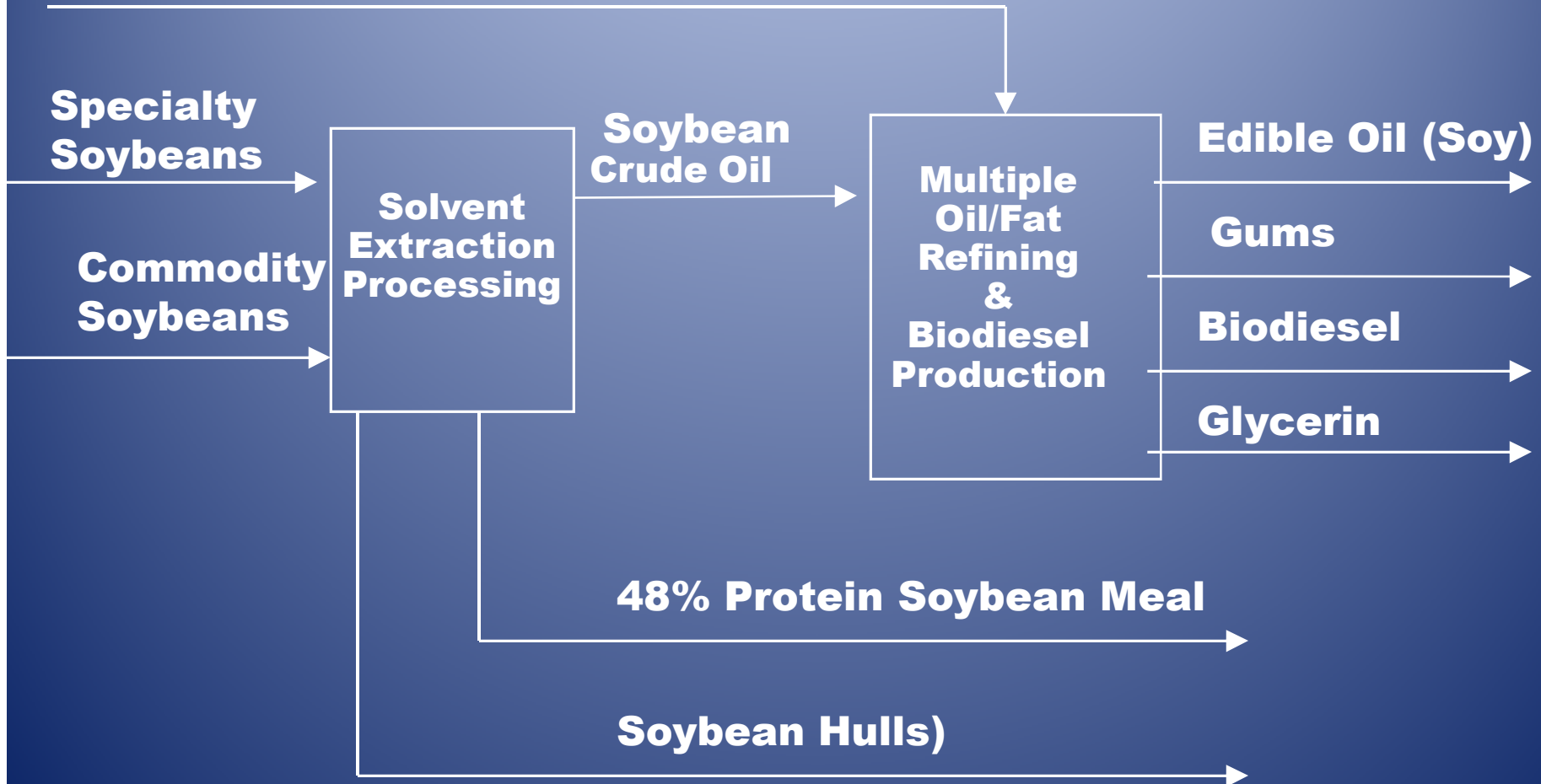
Glycerine/Feed
Fat

Commodity-Enhanced Soybean Meal

Soybean Hulls (Pelleted/Unpelleted)

SOYBEAN AND BIODIESEL PROCESS FLOW

Alternative Oil or Fat Feedstocks



Feedstock Production

- Feedstock production for this paper is based on the conversion of soybean oil (from a Crush Plant) into a fatty acid methyl ester (FAME). FAME is fuel grade Biodiesel when it meets ASTM D6751-X specifications. The process is known as Base-Catalyzed Transesterification. This is accomplished by the reaction of the canola oil with methanol in the presence of a base catalyst, normally a form of sodium hydroxide, mixed with methanol and sold as sodium methoxide. Other minor chemicals are also involved in the reaction.

Major Biodiesel Cost

- Feedstock can represent 75% to over 80 % of the cost of Biodiesel
- The dominant feedstock in Brazil and the U.S. is soybean oil.
- The dominant feedstock in Canada is canola oil

New Oilseed Varieties

Many new oilseed varieties and oil sources are being investigated including:

- Camolina
- Jatropha
- Cuphea
- Algae

SOYBEANS

- Dominant oilseed crop in both Brazil and the United States
- World Production of Soybeans = 237,797,000 MT
- Brazil produced 60,149,000 MT (May 2008)
- United States produced 70,359,000 MT (Jan. 2008)
- Argentina produced 51,810,000 MT (July. 2008)
- The “Big Three” produce over 76% of the world’s soybeans.



Soybeans and Canola

R.L. STROUP CO. LTD.

COMPOSITION of the SOYBEAN

	Range		Typical
Oil	18 to 20%		19%
Moisture	10 to 14%		12%
Protein	35 to 40%		38%
Fiber	6 to 8%		7%
Inert	22 to 26%		24%

After Extraction in Kg's per 100 Kg's of Soybeans

Oil	0.5 to 1.5 Kg		1.0 Kg
Moisture	10 to 14 Kg		12.0 Kg
Protein	35 to 40 Kg		38 .0 Kg
Fiber	2 to 4 Kg		3.0 Kg
Inert	22 to 26 Kg.		24.0 Kg
Total			78 Kg

38 Kg of Protein / 78 Kg. Total = 48.7% Protein

Integrated Oilseed Crushing Operation

- An economical effective biodiesel operation should include an integrated crushing operation
- The high value output of crushing is 48% protein meal for animal feed
- The demand for protein meal drives the soybean crush required

AUCTION

BIODIESEL REFINERY
www.maascompanies.com



Photos Wayne W. Kubert, MAI

Lender Ordered Collateral Sale
..... January 22, 2009
5 Million Gallon/Yr
B100 Biodiesel Refinery

Call for Complete Information!

Facility Newly Built in 2006-07 • Equipment Selling as a Unit • Currently Located on Leased Premises • Property Served by Rail Siding to Loading Dock
Sale with or without Existing Long-term Favorable Ground Lease • New Owner can Assume Lease and Operate On-Site or Re-locate Equipment to New Plant
Refined, Bleached Soybean Oil Feed • Equipment by DeSmet Process & Technology, Inc (desmet ballestra) of Marietta, Georgia

Terms: 10% Buyer Premium. 1% Broker. Sale Subject to Seller Confirmation. \$100,000 Certified Deposit on day of sale, balance due at closing within 30 days.

R.L. STROUP CO. LTD.

Biodiesel Yield

- A 378.0 mm liter/yr Biodiesel Process requires a crush of about 5525 MTPD (Received)
- A Solvent Extraction Process at 5525 MTPD produces about 996.4 MTPD of Refined, Bleached and Deodorized (RBD) oil.
- 996.4 MTPD of oil will produce about 994.4 MTPD of Biodiesel or 300,300 gal/day. At 8000 hr/yr. this equates to 100.0 mmgpy or 378.5 mm liter/yr.

Biodiesel Value vs. 48% Protein Meal Value

- 300,300 gallons/day of biodiesel @ \$2.65 per gallon = \$795,795
- The biodiesel revenue stream does not include the glycerin
- The 5550 MTPD crush will yield 3858.4 MT of soybean meal @ \$346.50/MT* = \$1,336,926.
- The 5550 MTPD crush will yield 314.5 MT of soybean hulls @ \$110.00/MT** = \$34,595.
- The combined value of the Hulls & Meal is \$1,371,521 vs. \$795,795 for the Biodiesel.

* The values above for soybean products are based on the Cash Market, WSJ, July 17, 2009.

** Feedstuffs, June 30, 2009

Biodiesel Value vs. 48% Protein Meal Value for 5525 MT Crush

- 300,300 gallons/day of biodiesel @ \$2.65 per gallon = \$795,795
- The biodiesel revenue does not include the glycerin
- Yield of soybean meal = 3858.4 MT @ \$385.03/MT* = \$1,485,600
- Yield of soybean hulls = 314.5 MT @ \$121.25/MT** = \$38,134
- The value of the Hulls & Meal is \$1,523,734 vs. \$795,795 for the Biodiesel.

*The values above for soybean products are based on the Cash Market, WSJ, July 21, 2009.

** Feedstuffs, June 8, 2009

*** Price , Chicago, Progressive Fuels, July 21, 2009

Perhaps “Oilseed Crushing” is a
misnomer!

Protein Seed Crushing might be a
more accurate term—especially for
soybeans.

The 'Magic Formula' for Chickens

- Corn (maize)
- Soybean Meal (48% protein)
- Fat (animal or vegetable)
- Premix (calcium, vitamins, trace minerals, etc.)

Result of Feeding Chickens the “Magic Formula”

- Egg hatching to marketable bird in 42 days or less.
- Feed Conversion: 1.95 kg of feed or less required to produce 1 kg of chicken.

Soybean Oil Quality

- The quality of soybean oil in terms of non-hydratable phosphatides (NHP), free fatty acids, color, stability, etc. does not begin in the Refinery—it begins in the crushing plant! In fact, soybean oil quality begins in the farmers' fields when the beans are harvested

Table 2--CRUDE SOYBEAN OIL QUALITY

Factors Affecting Quality	Resultant Increased Levels					
	Total gums (phosphatides)	Non-hydratable phosphatides	Free fatty acids (FFA)	Oxidation Products	Iron/meal Content	Pigments
Weed seed				X		X
Immature Beans						X
Field-damaged beans	X	X	X		X	
Splits from Handling	X	X	X			
Storage, time, temp.	X	X	X			
Pre-Flaking Conditioning	X	X		X	X	
Oil Stripper (overheating)		X				
Solv't Stripper (overheating)		X		X		
Oil storage (time/temp)			X	X		

CRUSHING PROCESS

1. Grain Unloading

7. Secondary DeHulling

2. Receiving & Cleaning

8. Flaking

3. Storage

9. Extraction

4. Drying

10. DeSolventizing

5. Tempering

11. Distillation

6. Primary DeHulling

12. DeGumming

Grain Unloading By Pneumatic Conveying

Bernoulli's Theorem: $P_1 V_1 = P_2 V_2$

- Where: P_1 = Pressure at inlet hose (vacuum)
- V_1 = Air Velocity at inlet hose (m/sec)
- P_2 = Pressure at discharge collector (vacuum)
- V_2 = Air Velocity at discharge collector (m/sec)

Pneumatic Conveying Systems

Considerations:

- Minimize the number of Elbows
- Use two 45° Elbows in place of one 90°
- Use Long Radius Elbows \geq 125 cm radius
- Minimize the conveying rates and velocities
- Make transitions long. 30° included angle is good, $< 30^\circ$ is better.

Pneumatic Conveying Systems

More Considerations:

- Keep Flexible Hoses as straight as possible
- Chamfer the inside diameter of pipe to eliminate sharp edges
- Maintain Rotary Airlock/Rotor tip clearances
- On spouts, use “Dead Boxes” where possible, so that beans hit beans—not steel.

Truck Unloading

- Hopper-Bottom Trucks up to 42 MT
- Tandem Trailer Units=Super “B” Tankers
- Dump Trailers up to 25 MT
- Adequate Unloading Pits
- Adequate Aspiration (Dust Control)
- Design Receiving Pits for all Trailer Types

Bucket Elevators



BREAKAGE OF SOYBEANS

Drop height (ft / meters)	Onto concrete (%)	Onto soybeans (%)
100 ft (30.5 m)	4.5	3.2
70 ft (21.3 m)	2.1	1.4
40 ft (12.2m)	1.1	0.7

Green Beans

Split Beans



Mold Growth

Aeration

Maximum Moisture for Safe Storage

13%

Equilibrium Values for Soybeans at 25°C

- | <u>Relative Humidity</u> | <u>Moisture</u> |
|--------------------------|-----------------|
| 35% | 6.5% |
| 50% | 8.0% |
| 60% | 9.6% |
| 70% | 12.4% |
| 85% | 18.4% |

- Source: Barger, W.M. J. Amer. Oil Chem. Soc. 58:154 (1981).

Typical Soybean Aeration



R.L. STROUP CO. LTD.

Top Section Soybean Storage



R.L. STROUP CO. LTD.

Heat Build Up in Storage

- Heat Detection in Storage is a must.
- Heat Detection Systems Control Aeration
- Heat Detection Systems Prevent Fires

DRYING

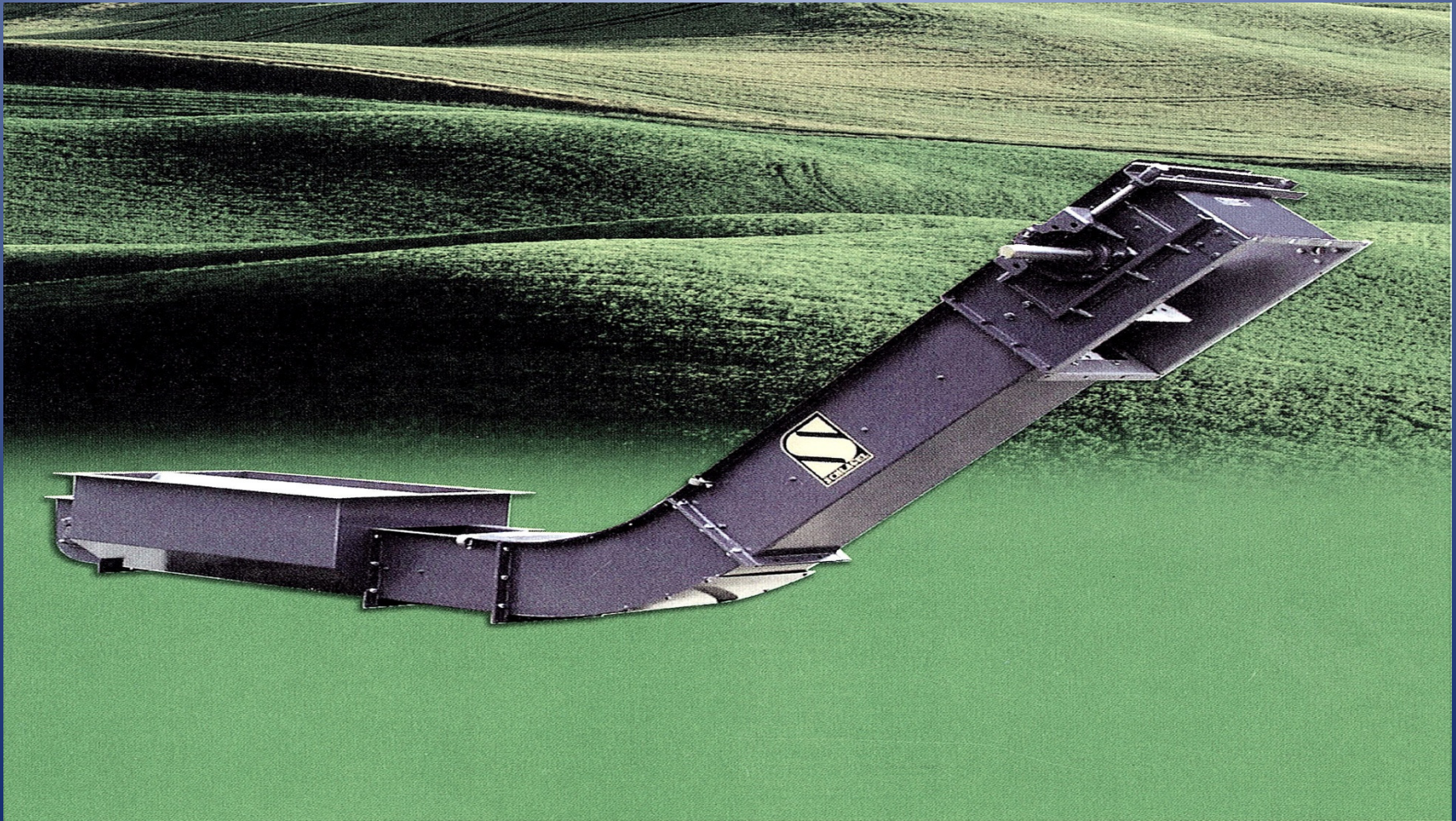
- Received and stored at 12% to 13%
- Dry to 9.9% to 10.4%
- Target at 10.2% (+/- 0.2%)
- Dryer Temp < 93° C (200 ° F)
- > 93° C inlet air causes heat damage
- >76°C (169°F) bean temp., protein digestibility issues

Bucket Elevator

R.L. STROUP CO. LTD.



Inclined Drag Conveyor



R.L. STROUP CO. LTD.

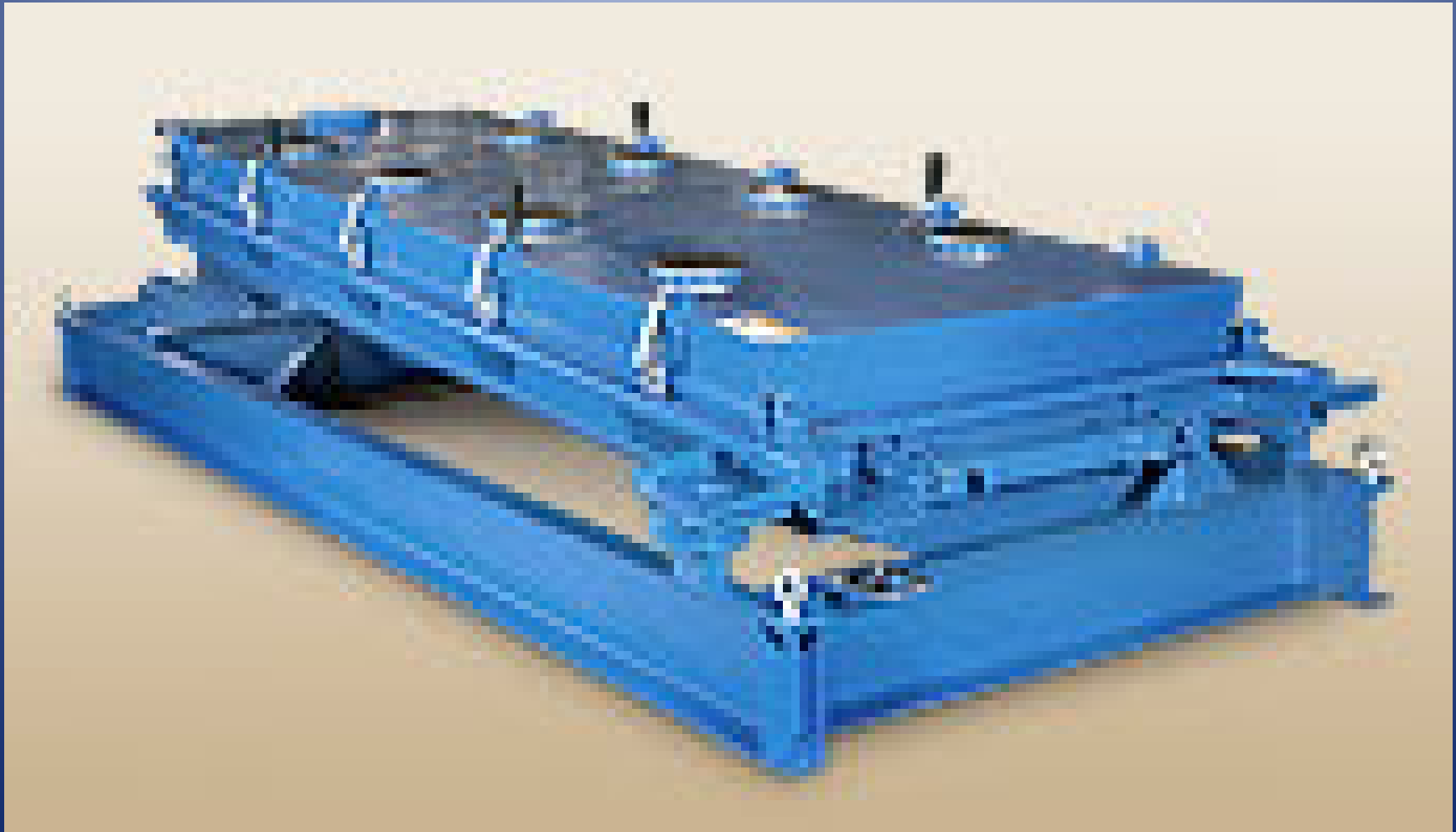
Tempering

R.L. STROUP CO. LTD.

CLEANING

R.L. STROUP CO. LTD.

Rotex Cleaner



R.L. STROUP CO. LTD.

- **Overs Removal**
- **Fines Removal**
- **Size Classification**

Table 5-Statification

COARSEST

COARSER

COARSE

FINE

FINER

FINEST

GOOD OIL QUALITY

Remove Weed Seeds

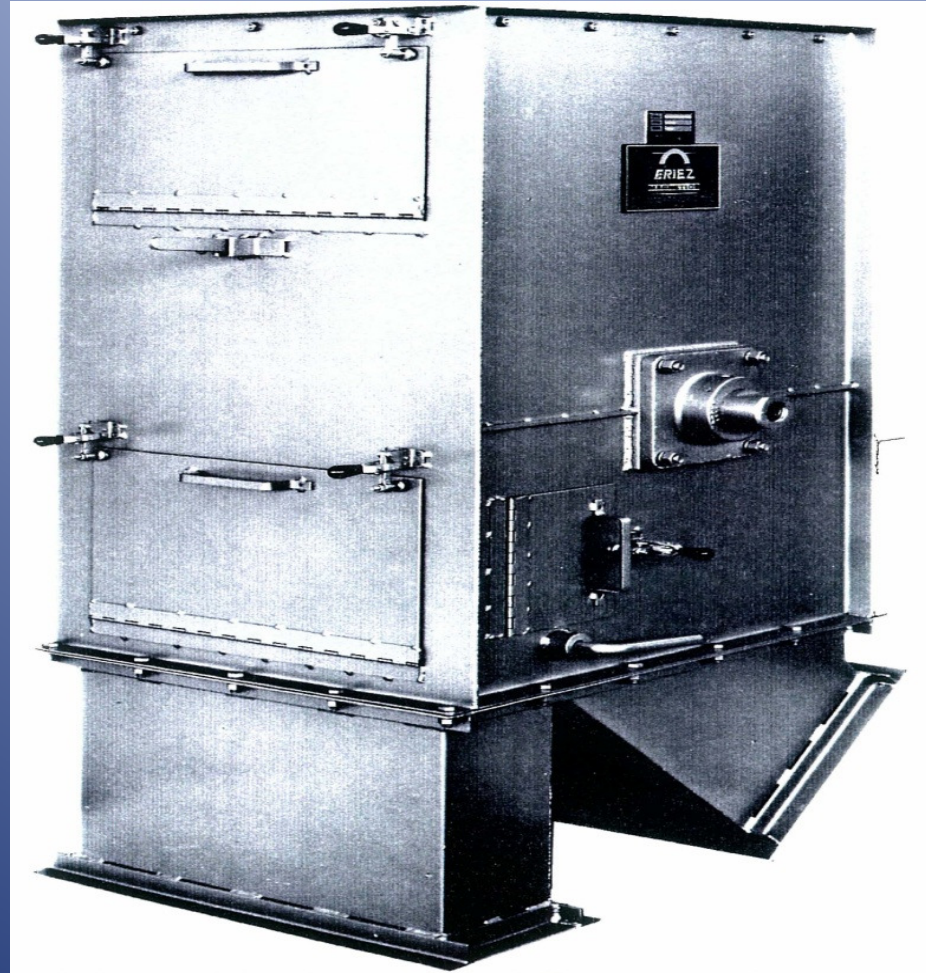
TEMPERING

R.L. STROUP CO. LTD.

All Beans are Not Created Equal

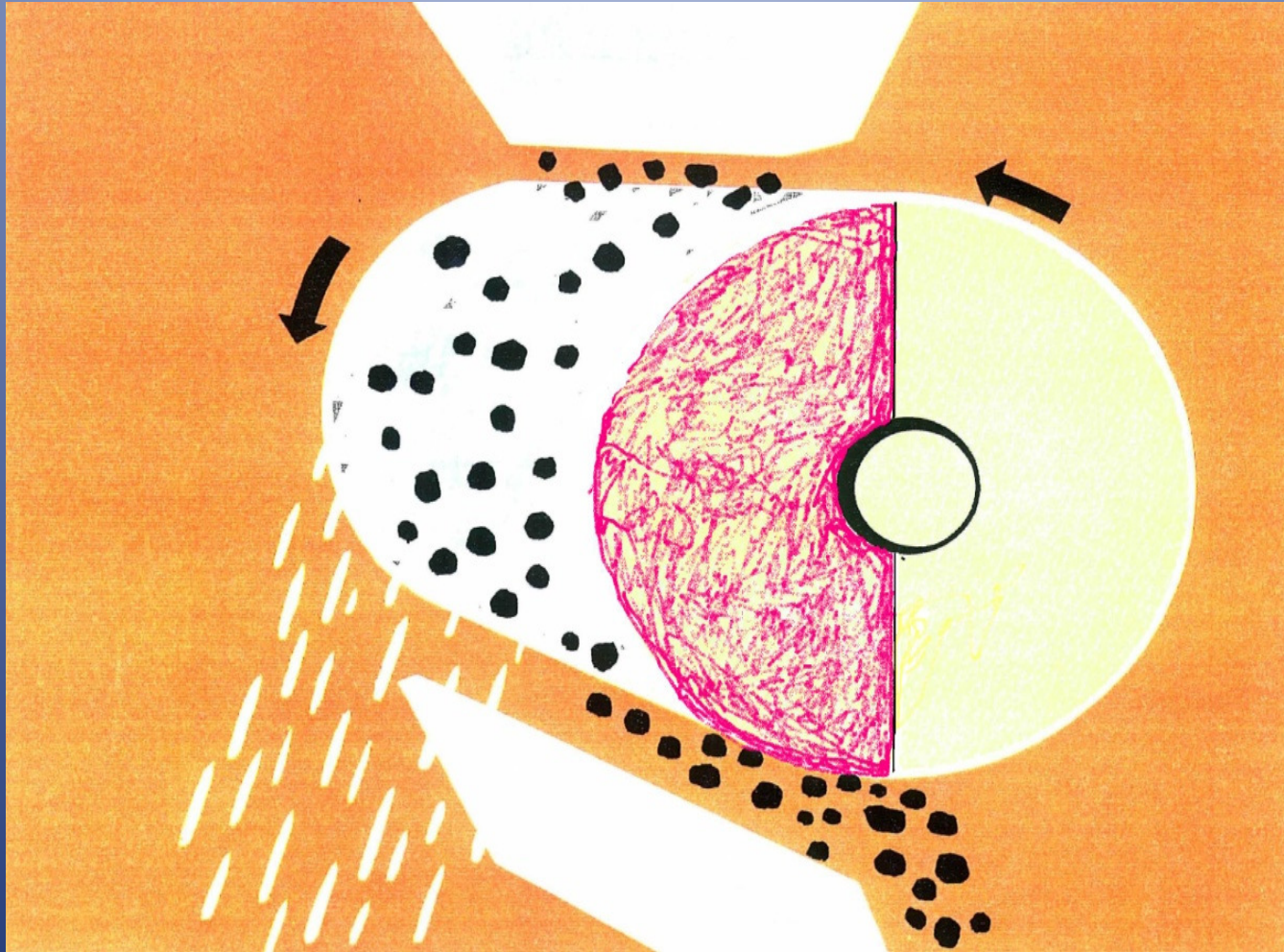
Primary DeHulling

Rotary Drum Magnet



R.L. STROUP CO. LTD.

Rotary Drum Magnet Operation



R.L. STROUP CO. LTD.

Cracking



R.L. STROUP CO. LTD.

Cracking Mills

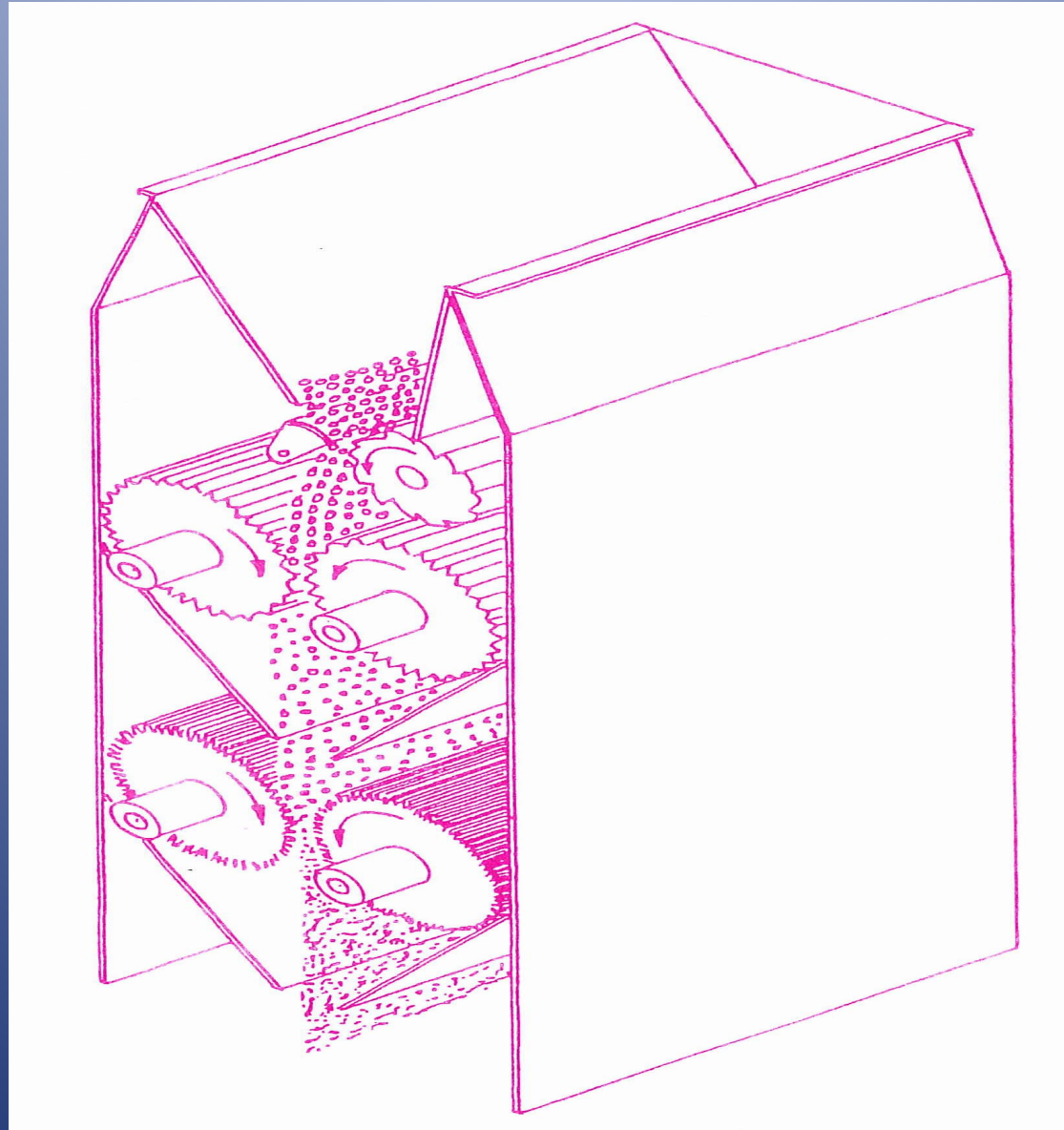
R.L. STROUP CO. LTD.

Two High Cracking Mill



R.L. STROUP CO. LTD.

Operation of Cracking Mill

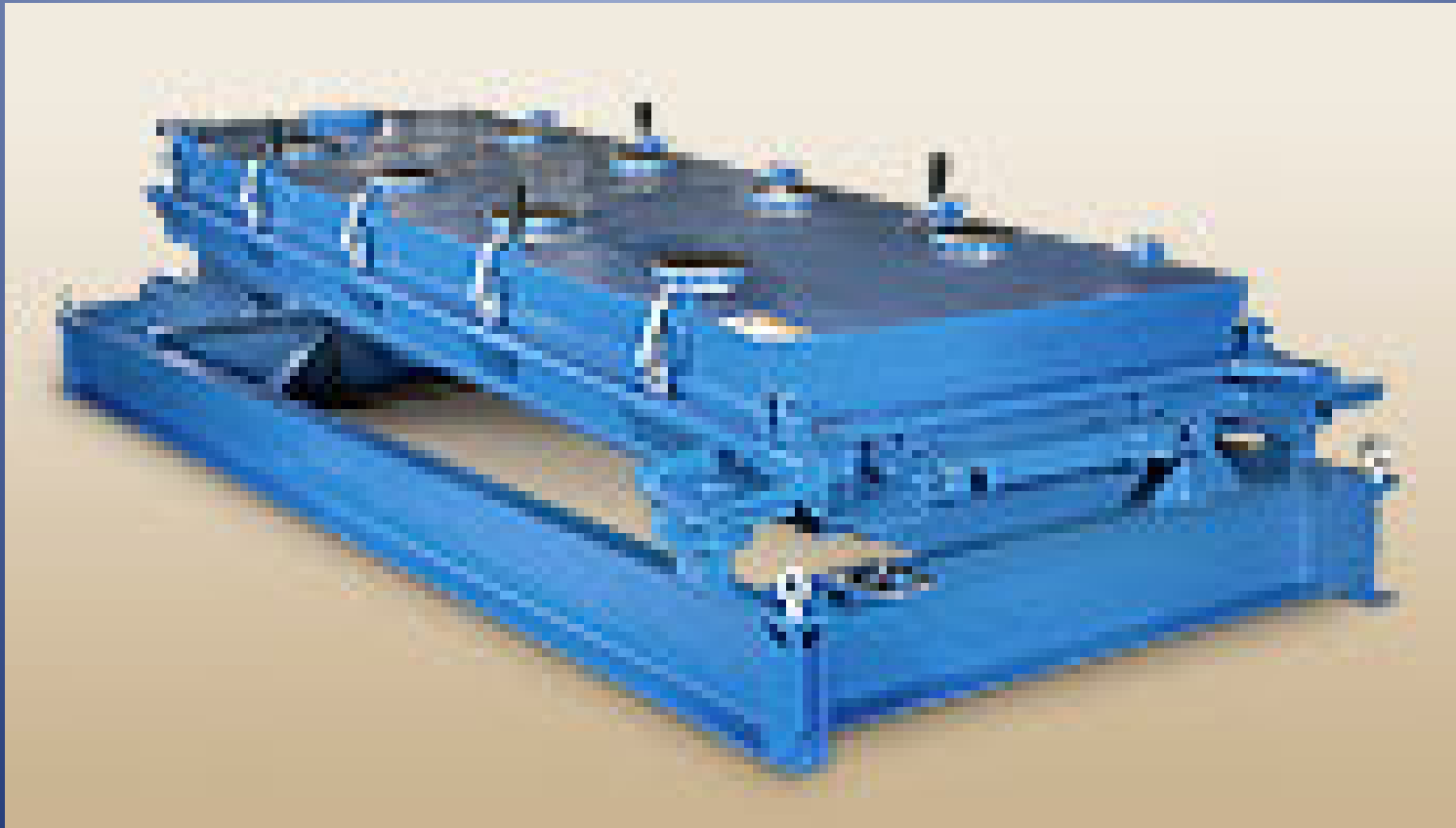


R.L. STROUP CO. LTD.



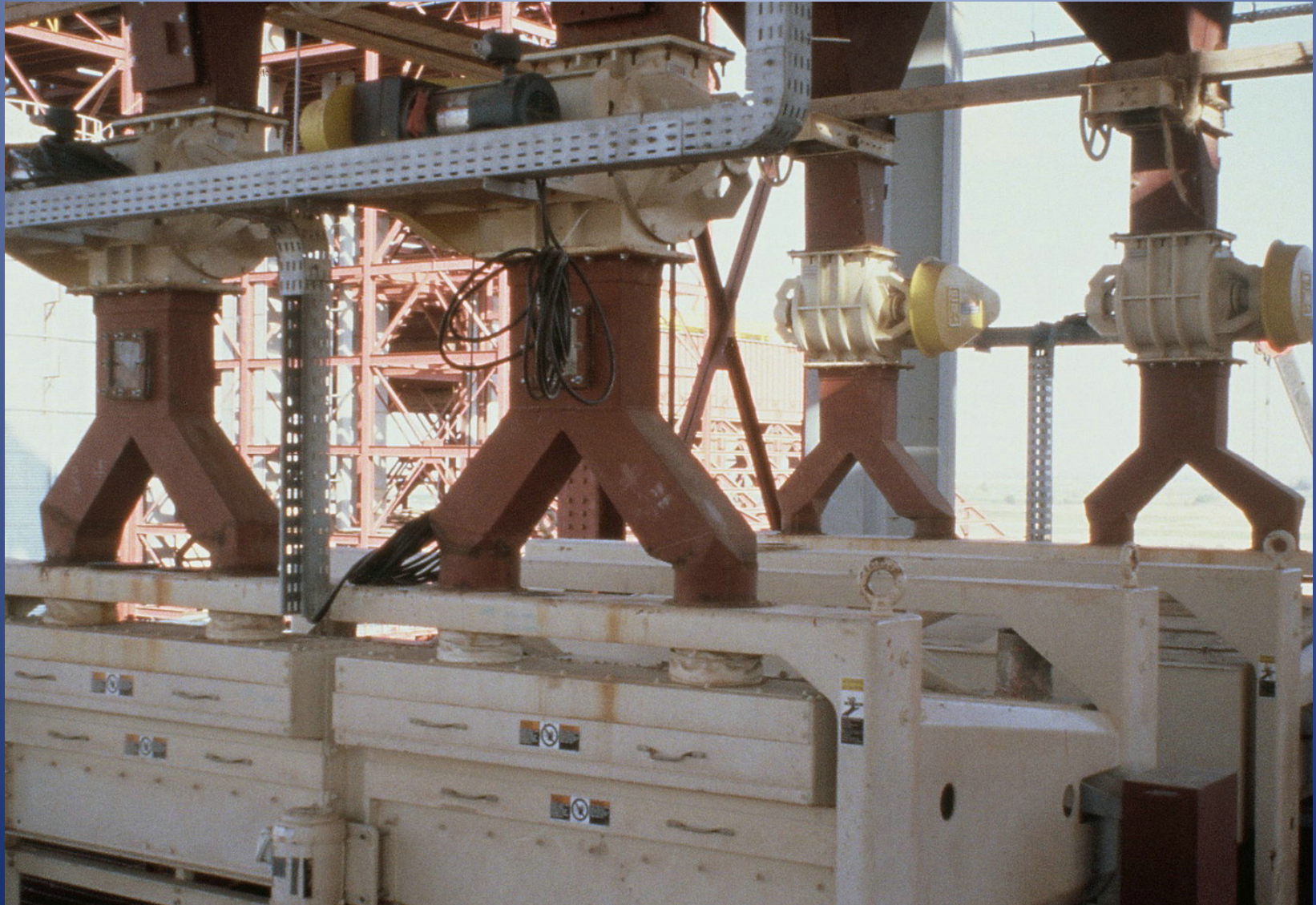
R.L. STROUP CO. LTD.

Rotex Screener



R.L. STROUP CO. LTD.

Cleaner Installation



R.L. STROUP CO. LTD.

Crack Profile

- + 6 mesh -- 10 to 15%
- + 10 mesh -- 60 to 70%
- + 20 mesh -- 5 to 15%
- 20 mesh -- 0 to 3%

FLAKING

R.L. STROUP CO. LTD.

Pre-Conditioning

Pre-Conditioning

- Heat soybean cracks to 72° C (160° F) prior to Flaking—Better flakes, less fines
- Water or steam can be sprayed onto cracks to adjust the crack moisture if necessary
- Cracks that are too dry will make poor flakes

Vertical Steam Deck Conditioner



R.L. STROUP CO. LTD.

Rotary Steam Tube Conditioner



R.L. STROUP CO. LTD.

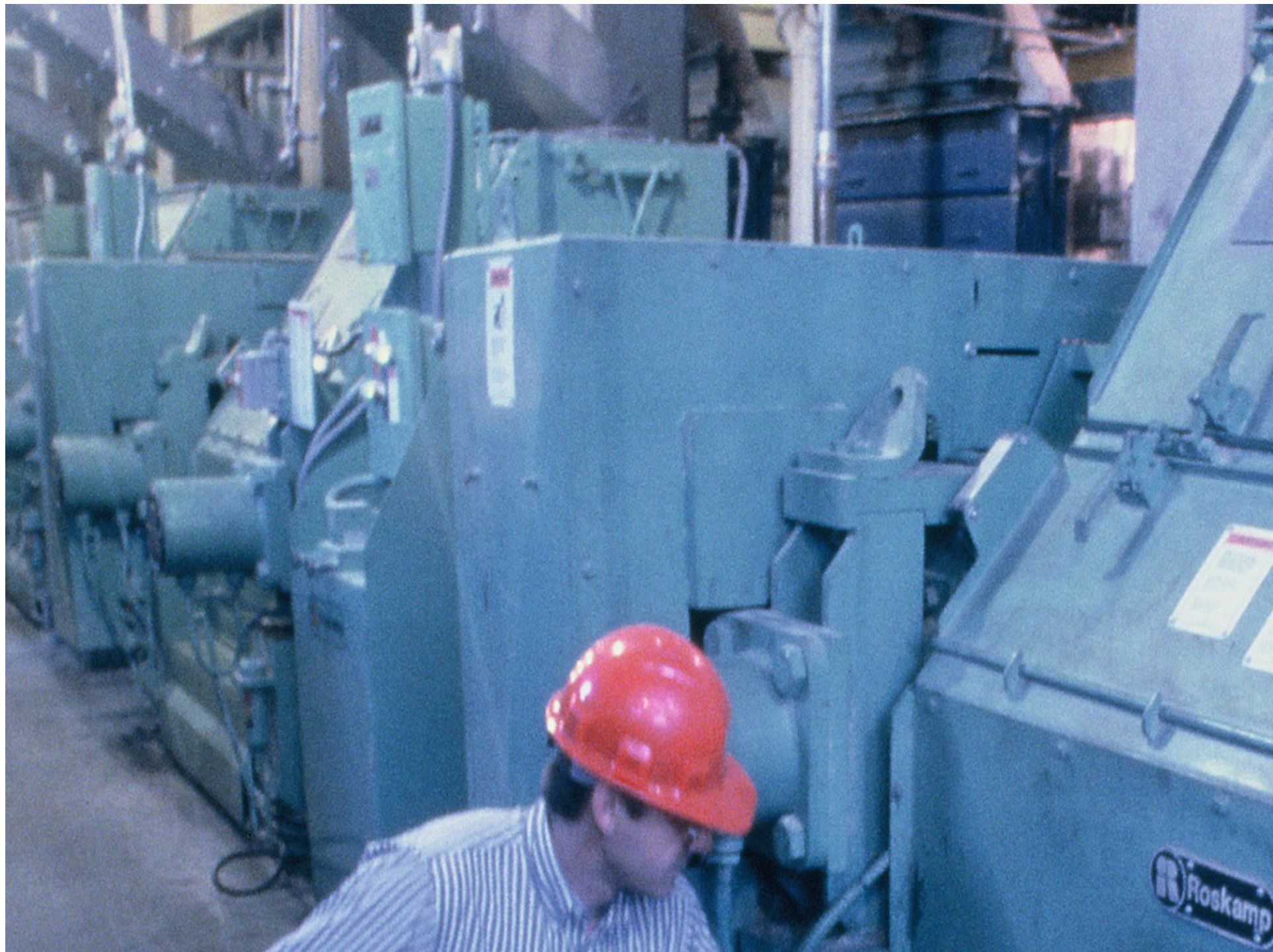
Hot Dehulling

- Used by many plants
- Does not require Tempering
- Some problems with wet beans
- Uneven drying at times

Flaking Mill

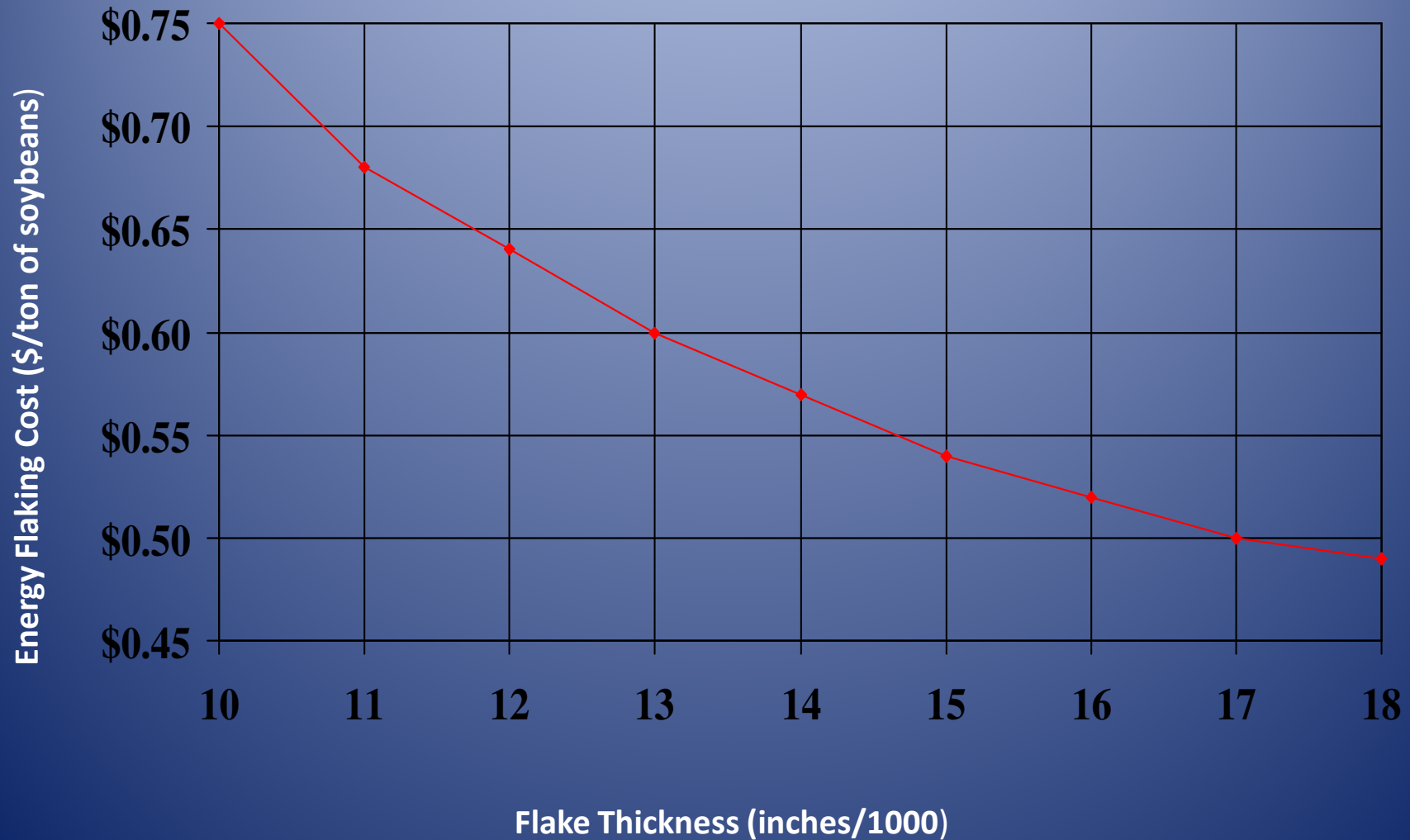


R.L. STROUP CO. LTD.



**FLAKER HORSEPOWER IS INVERSELY
PROPORTIONAL TO FLAKE THICKNESS.**

FLAKING COST VS. FLAKE THICKNESS



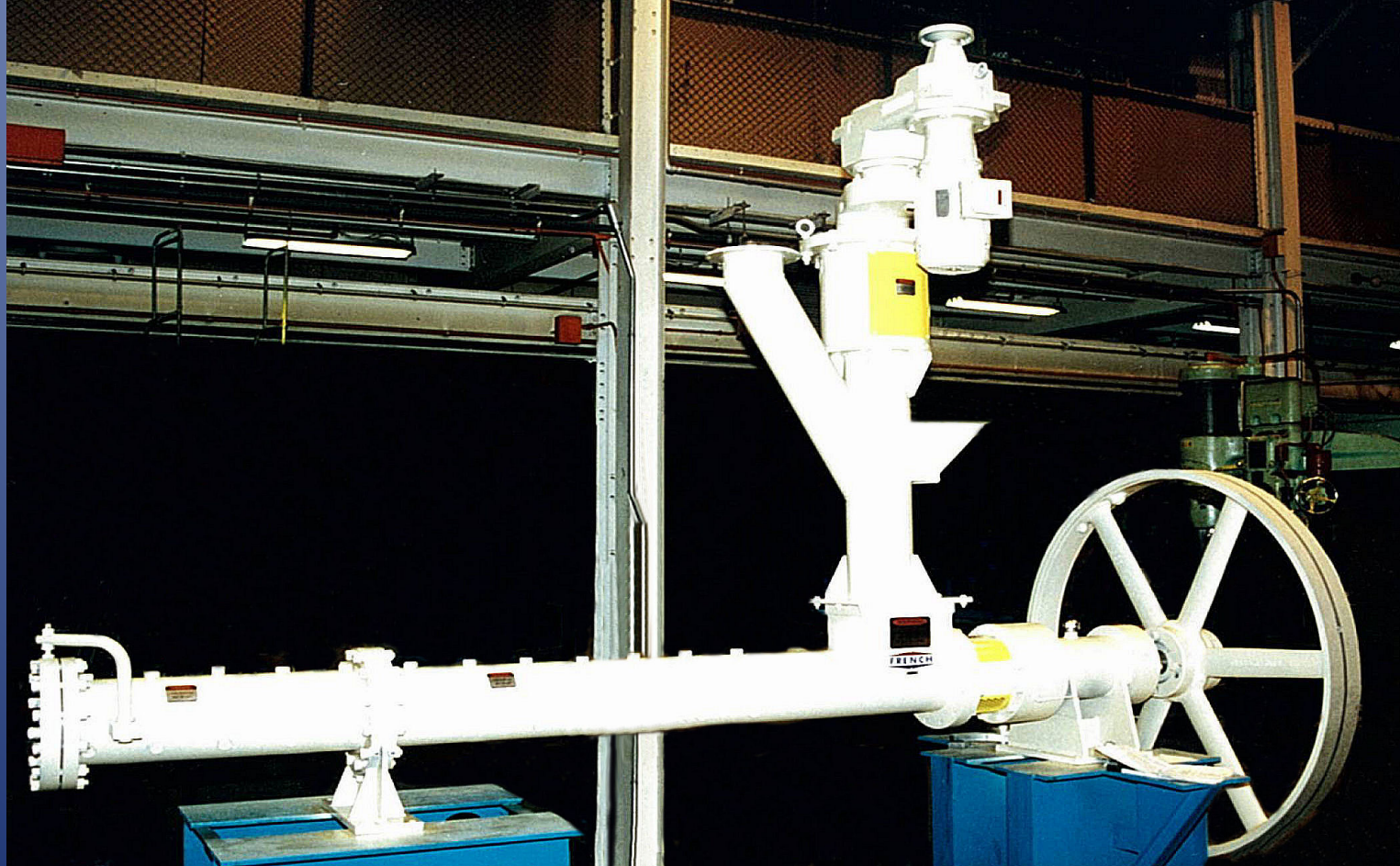
Thick Flakes vs. Thin Flakes

- Cost for 0.012" (0.30 mm) Flakes = \$0.54 /ton
- Cost for 0.015" (0.38mm) Flakes = \$0.40 /ton
- DIFFERENCE: \$0.14 /ton

- Savings/Yr = \$0.14 x 1200 MTPD x 350 d/yr.
= \$58,800 / yr.

- Savings/Yr = \$0.14 x 5525 MTPD x 350 day/yr =
\$270,725 / yr

ENHANSER PRESS



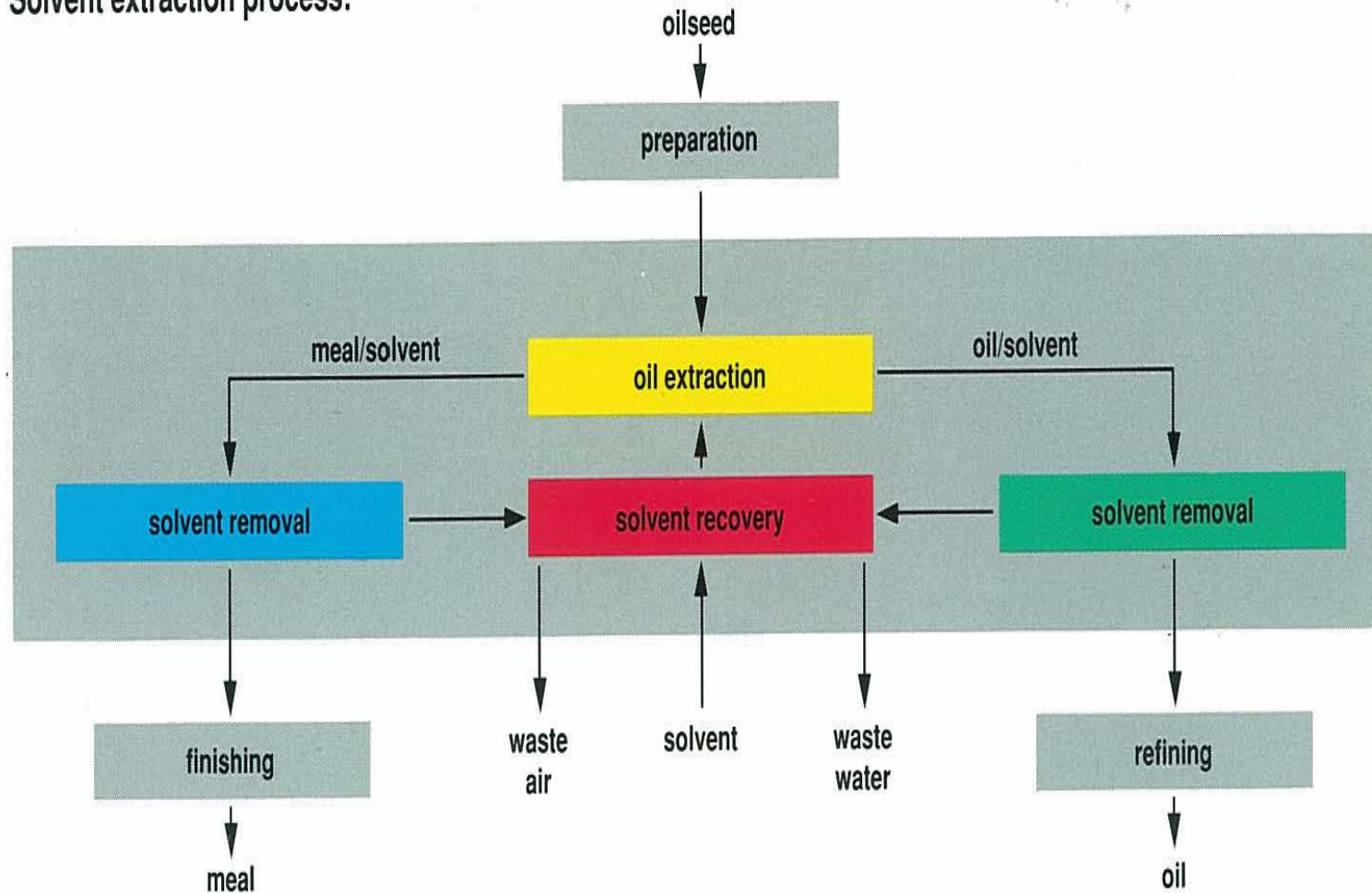
R.L. STROUP CO. LTD.

SOLVENT EXTRACTION

R.L. STROUP CO. LTD.

SOLVENT EXTRACTION PROCESS

Solvent extraction process:



COMMON EXTRACTOR TYPES

- Shallow Bed Extractor-Conveyor Type
- Medium Bed Extractor-Conveyor Type
- Deep Bed Extractor-Rotating Round Dividers

Extractor Types

- Percolation Continuous Counterflow
used by shallow or medium bed designs
- Immersion Continuous Counterflow
used by deep bed designs

In-Situ Transesterification

- Developed by Dr. Michael Haas, ERRC, USDA
- Flakes are directly reacted with alcohol
- Base Catalyzed-Reaction for several hours
- Fatty Acid Alcohol Ester + Glycerin
- High ratio of alcohol to flakes required
- Alcohol recovery = high energy
- Current work is reducing molar ratio of alcohol

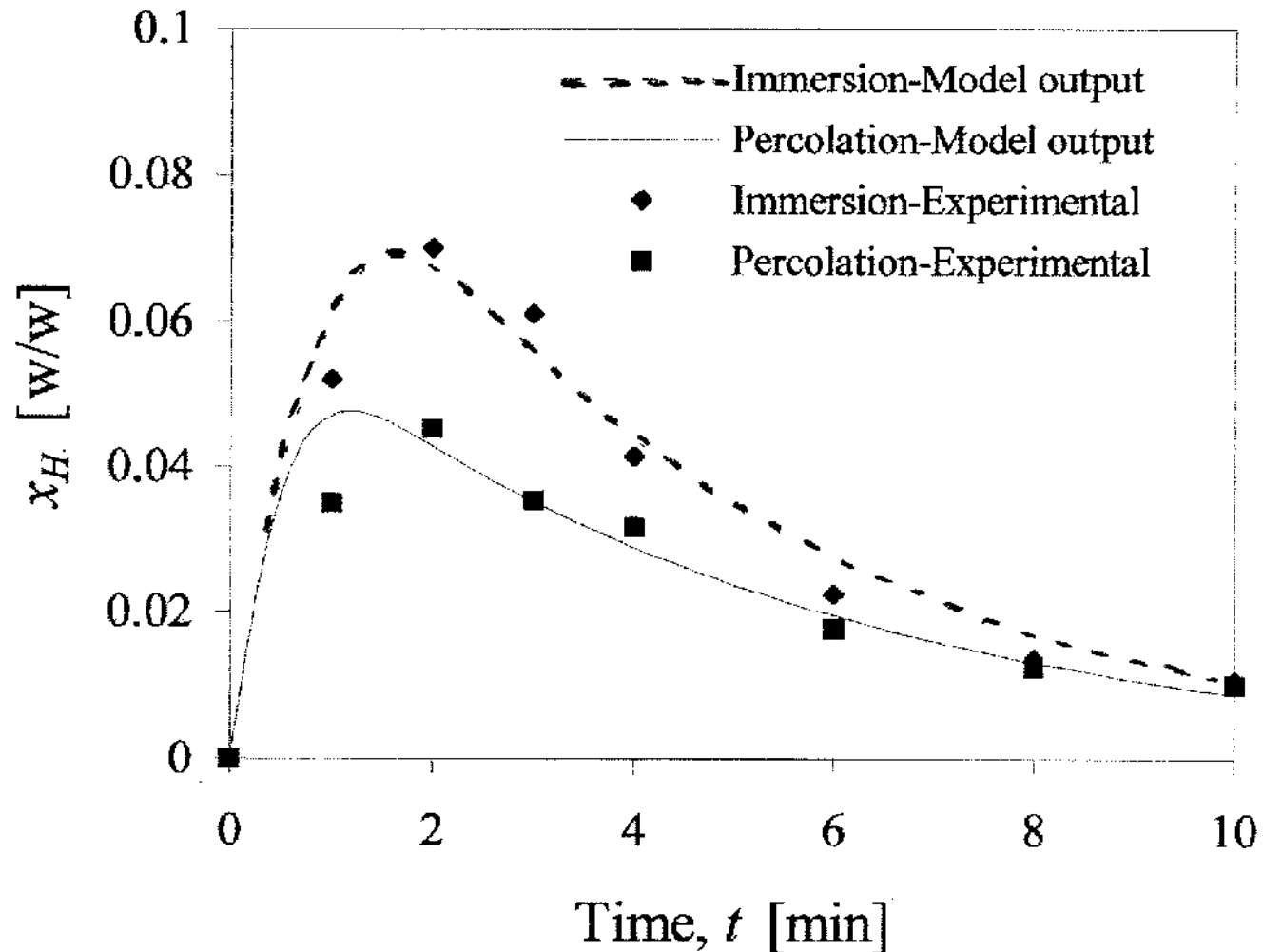


FIG. 1. Oil concentration at bed outlet in a deep-bed arrangement. Solvent flow: 0.59 L/min; model parameters: ε_p = particle porosity = 0.3; ε_l bed porosity = 0.5; D_p = molecular diffusion coefficient = $9.33 \cdot 10^{-10}$ m²/s; D_z = axial dispersion coefficient = $9.86 \cdot 10^{-6}$ m²/s; k_x = mass transfer coefficient = $1.42 \cdot 10^{-5}$ m/s; K = equilibrium constant = 0.6; x_{∞} = oil concentration in the miscella leaving the bed

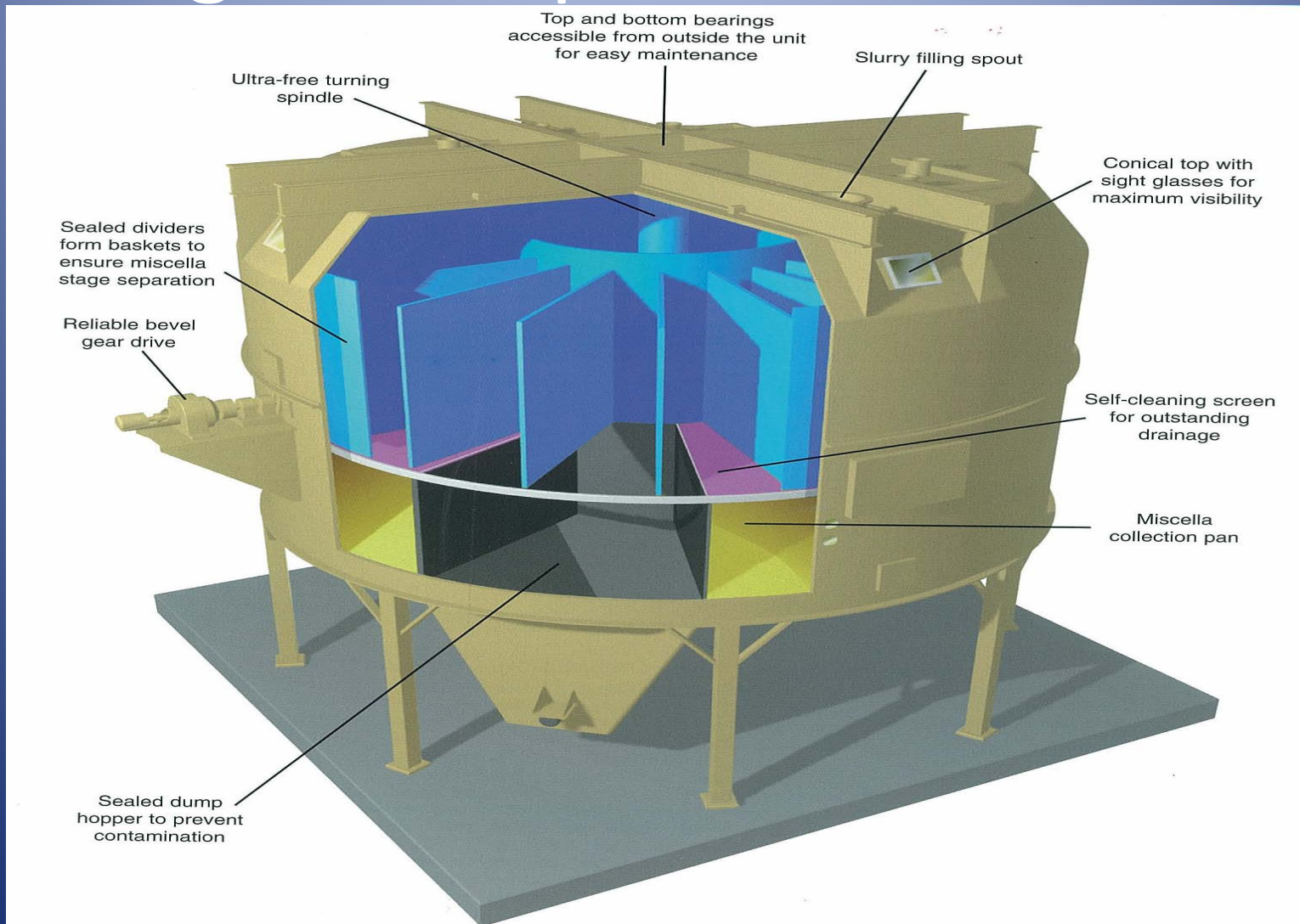
Deep Bed Extractor

- Uses Both Solvent Immersion Technology
- 3.0 meter (10 Ft.) Deep Bed
- Contains a series of Seal Basket Dividers
- Less Stage Pumps than other Designs
- Difficult to add to for additional capacity
- Largest unit--8165 MTPD @ 45 min.
- Largest Unit—10886 MTPD @ 35 min.

Fig. 01- Extraction Operation with Deep Bed Unit

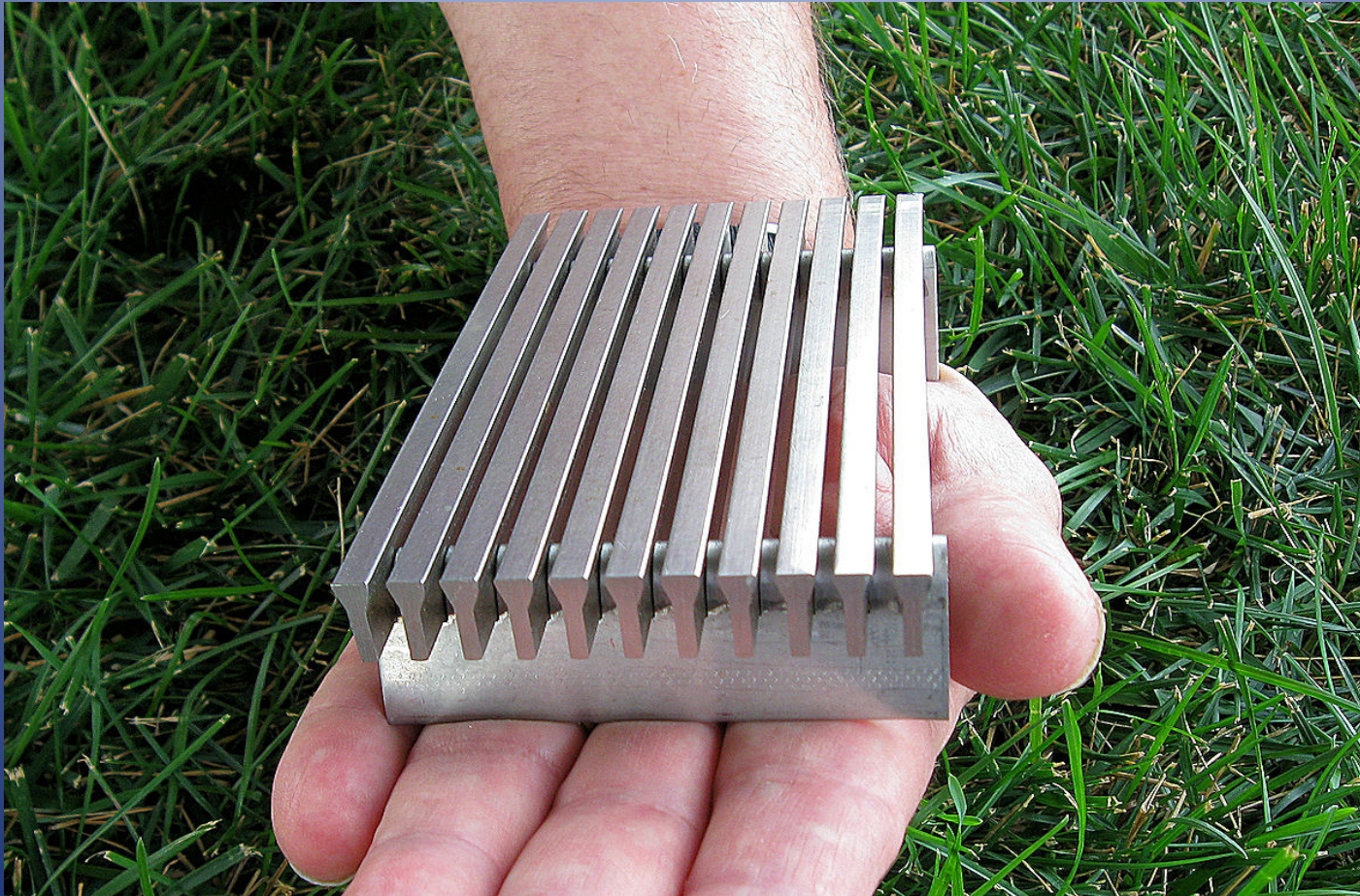


Fig.02-Deep Bed Extractor



R.L. STROUP CO. LTD.

Wedge Wire Extractor Bottom



R.L. STROUP CO. LTD.

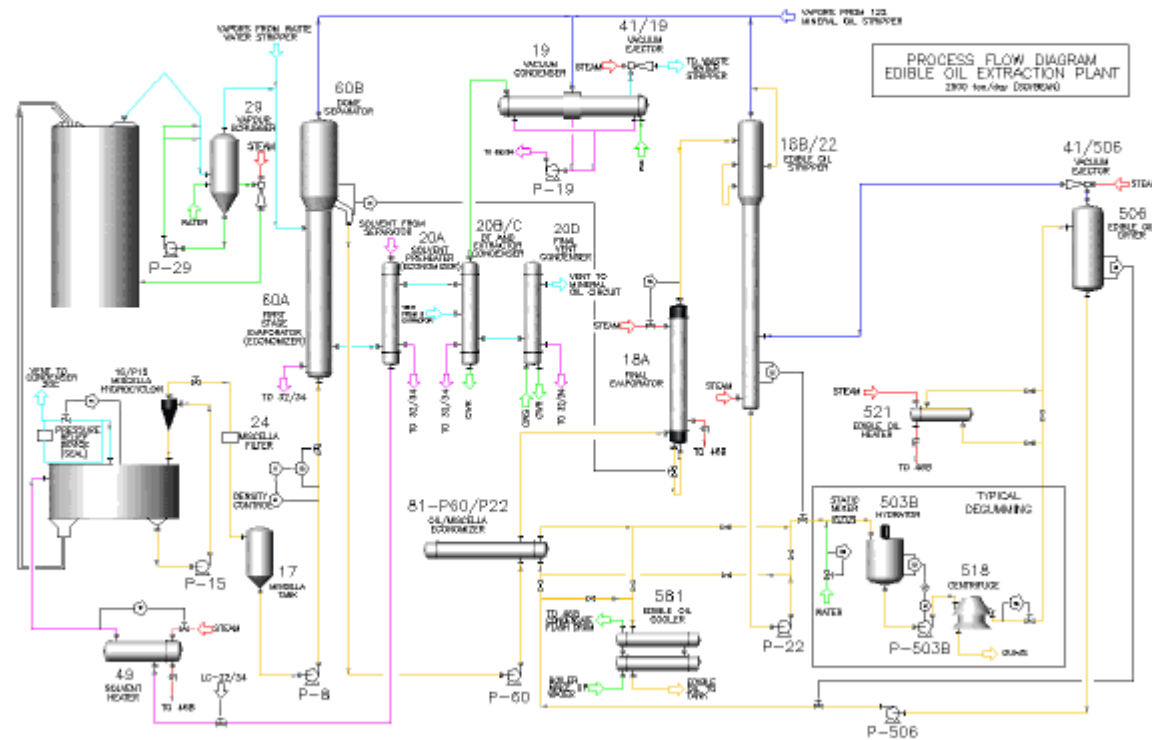


Deep Bed
Extractor

Pinch Analysis - Case I

Desmet / Hytech

Process Flow Diagram - I



R.L. STROUP CO. LTD.

Diagram 01--Meal/Solvent Flow

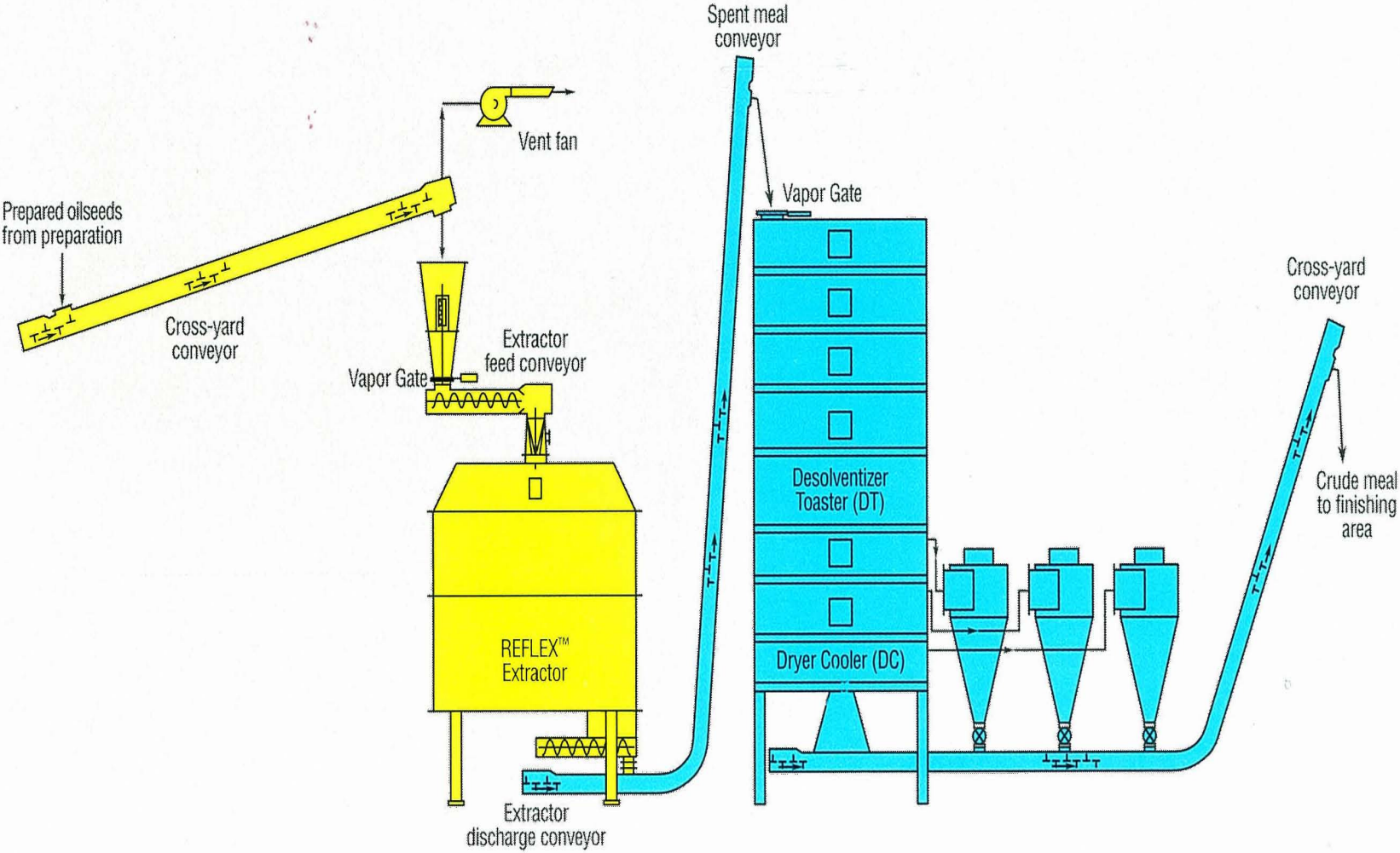


Diagram 02-Oil/Solvent Flow

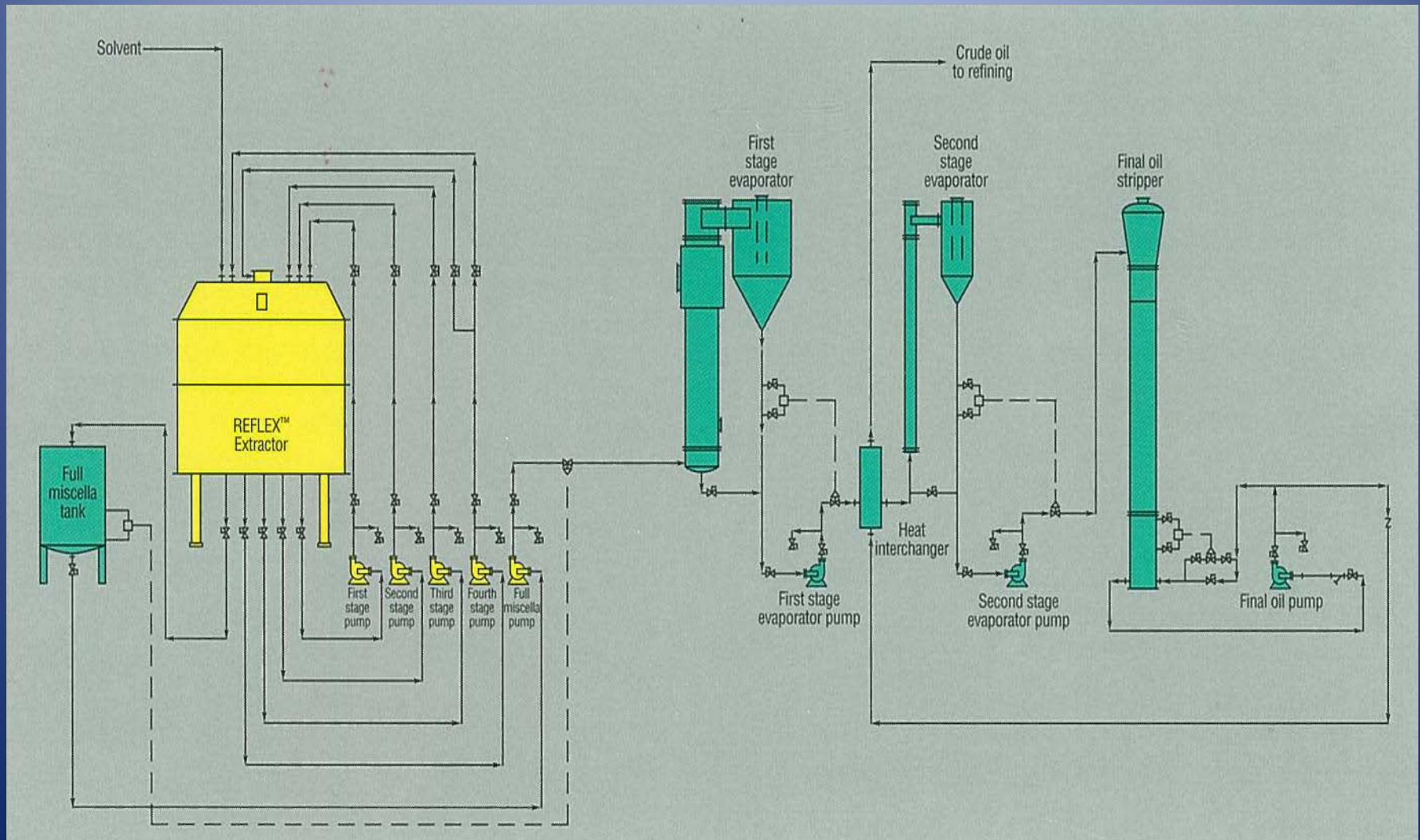
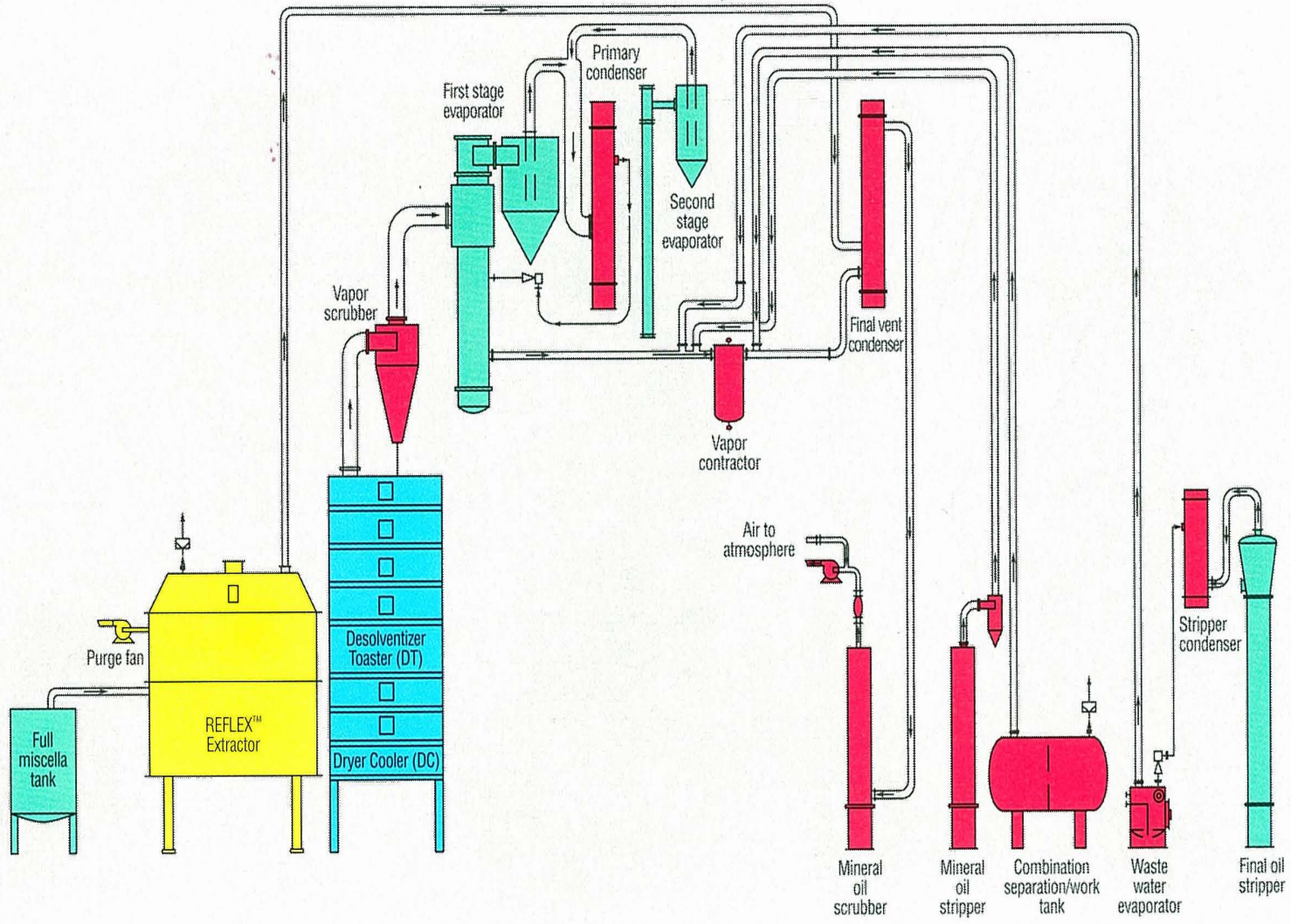


Diagram 03—Vapor/Air Flow



R.L. STROUP CO. LTD.

Diagram 04—Mineral Oil Flow

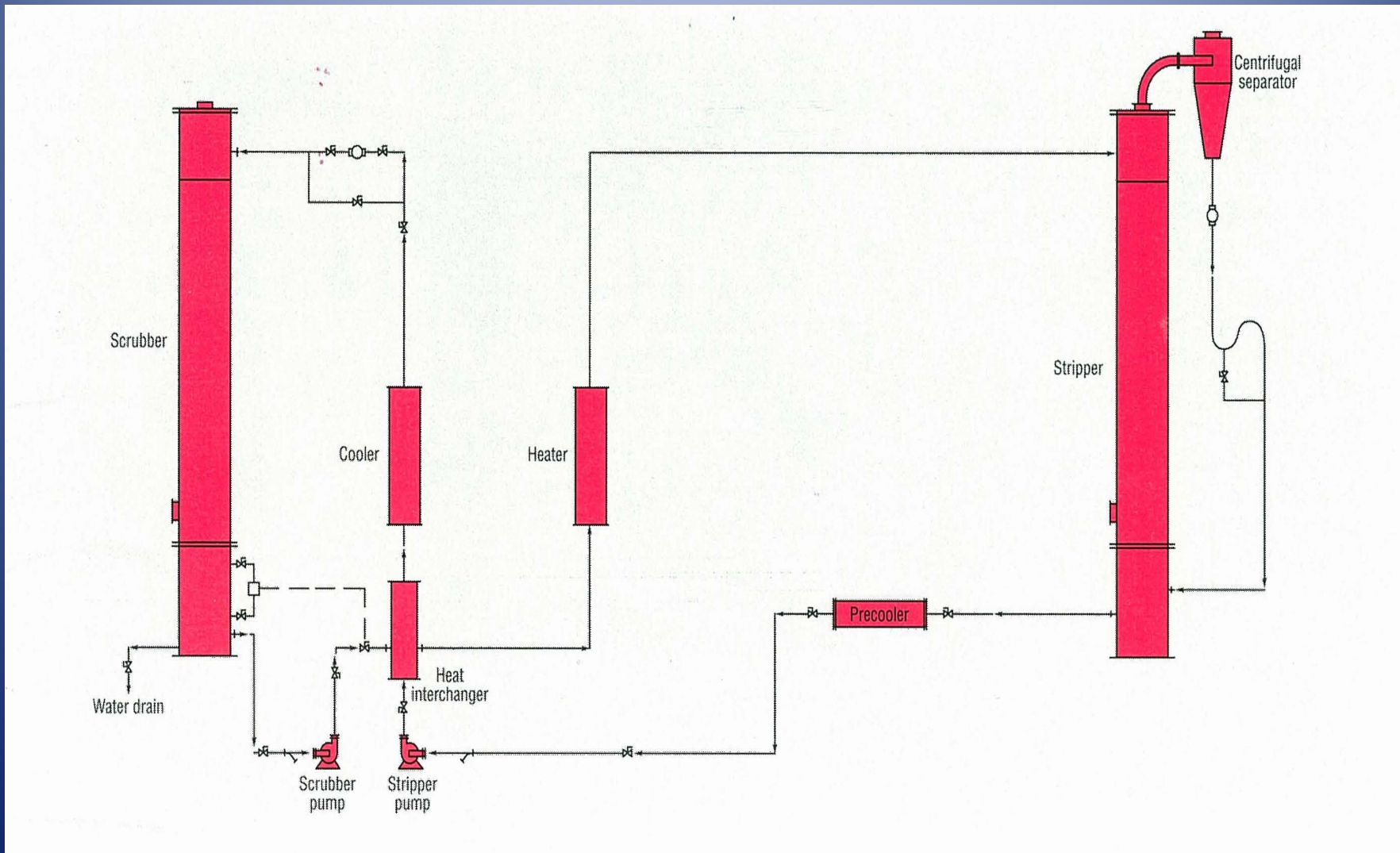
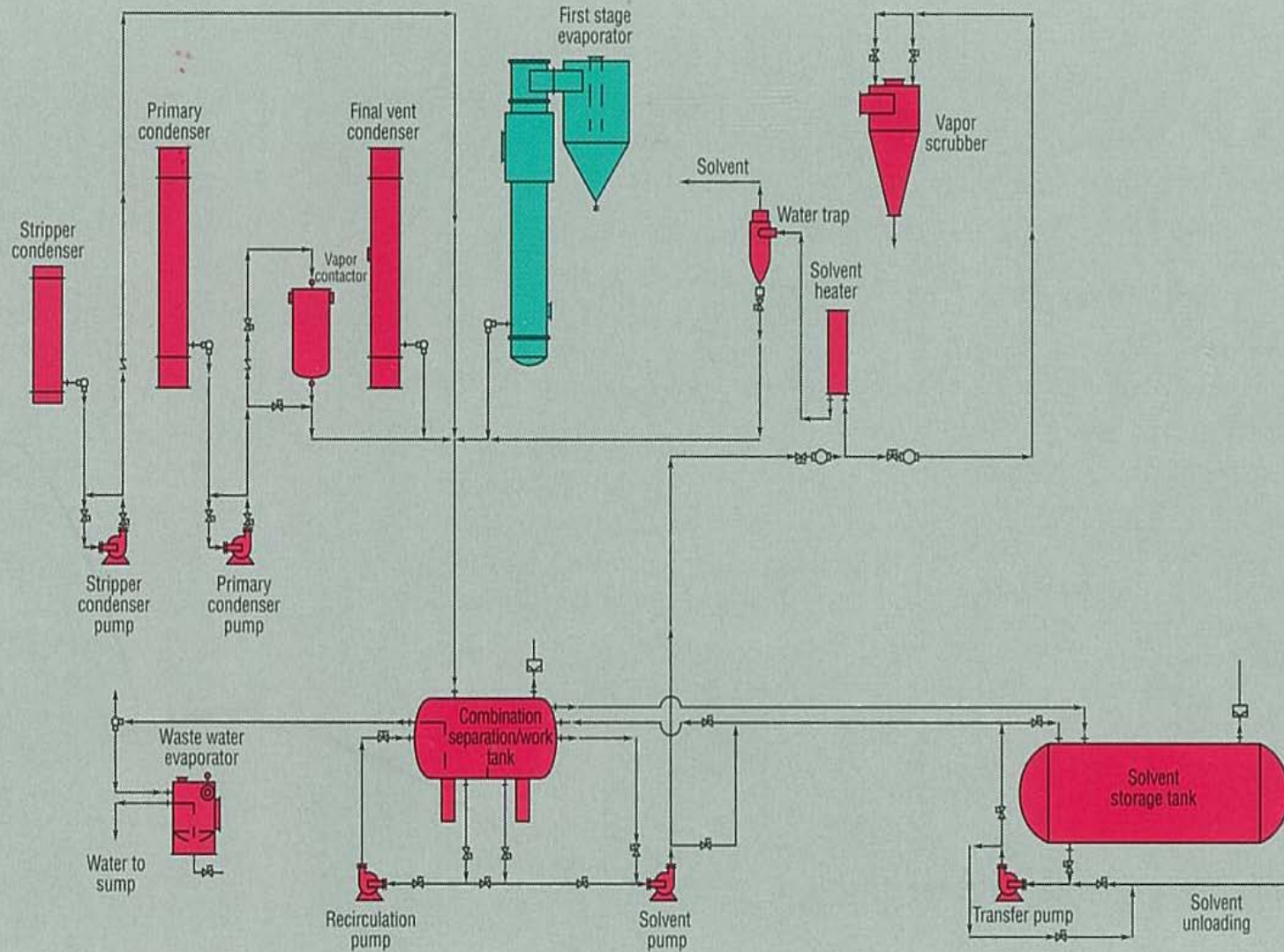


Diagram 05—Solvent/Water Flow

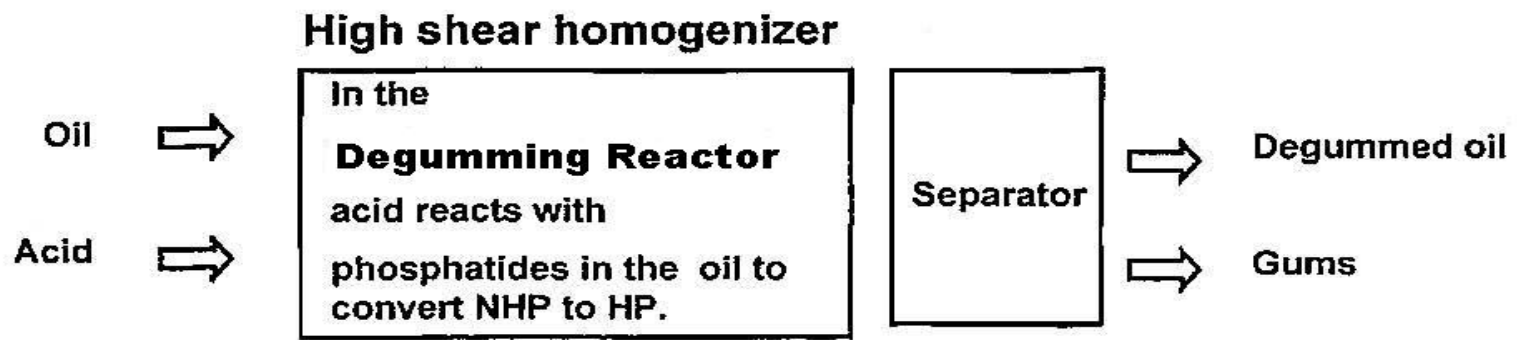


Degumming

R.L. STROUP CO. LTD.

Degumming

Degumming:



- oil is heated up to approx. 50°C
- mixed with up to 0.20% of phosphoric acid or citric acid

Solvent Recovery

R.L. STROUP CO. LTD.

Cost Saving Opportunities

- First Stage Evaporator-replace undersized
- Place Miscella Oil Interchanger between 1st and 2nd Stage Evaporators
- Place a Heat Exchanger between the Mineral Oil Heater and the Mineral Oil Cooler Mineral

.. *What is Pinch Analysis?*

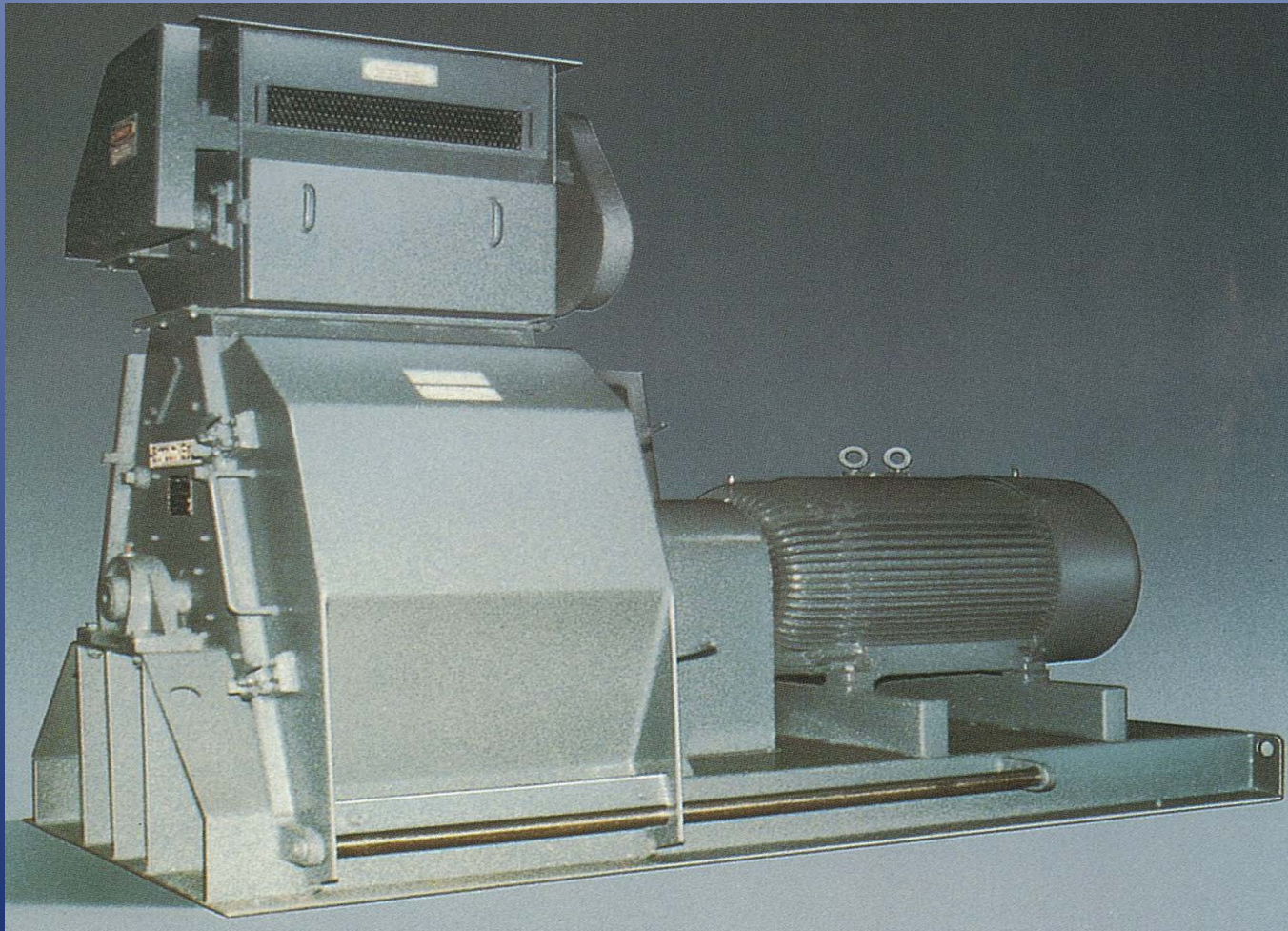
Desmet / Hytech

- ✦ *A systematic methodology based on thermodynamic principles to achieve utility savings by better process heat integration, maximizing heat recovery and reducing the external utility loads (cooling water and heating steam).*

Soybean Meal Processing

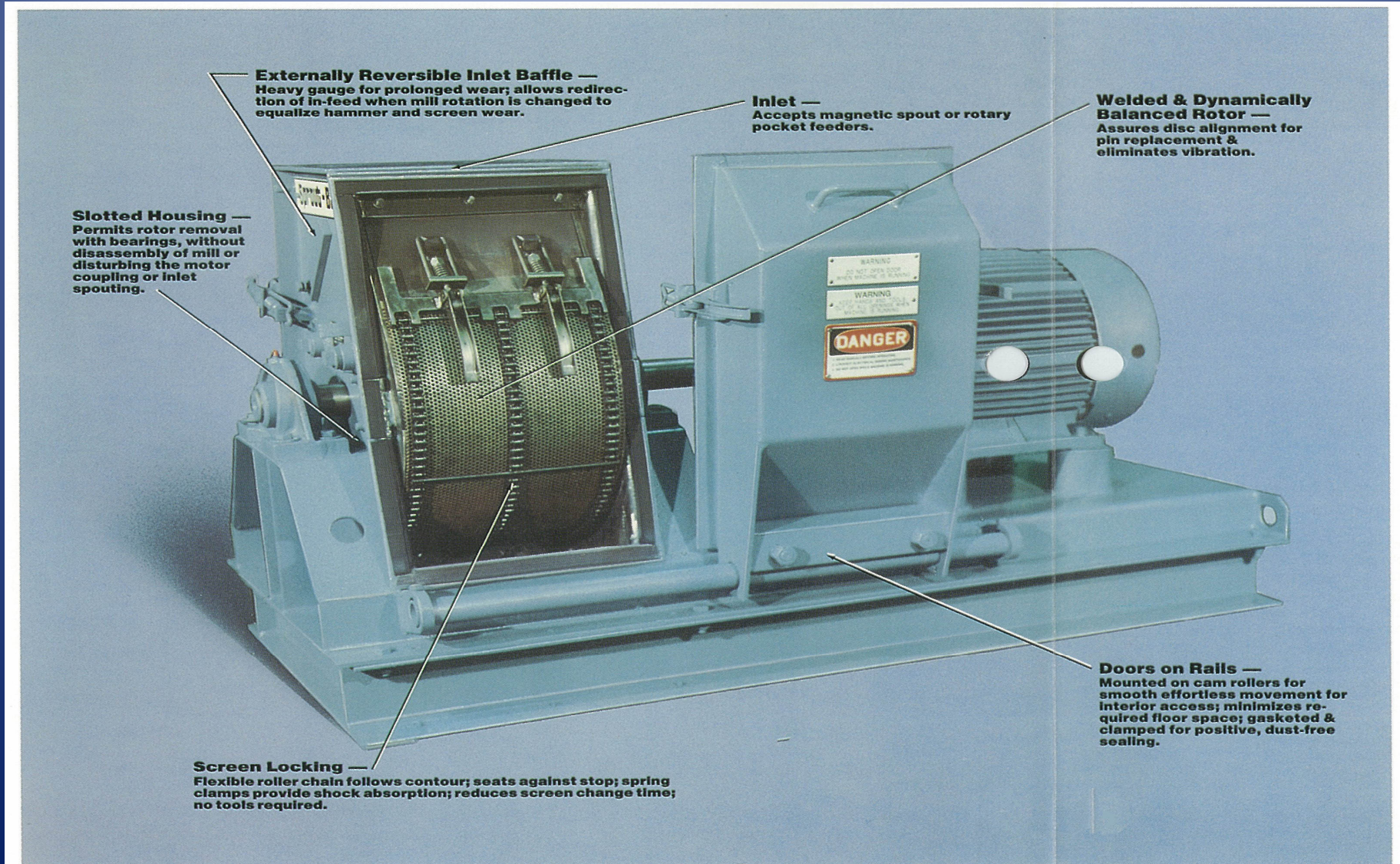
R.L. STROUP CO. LTD.

Hammermill

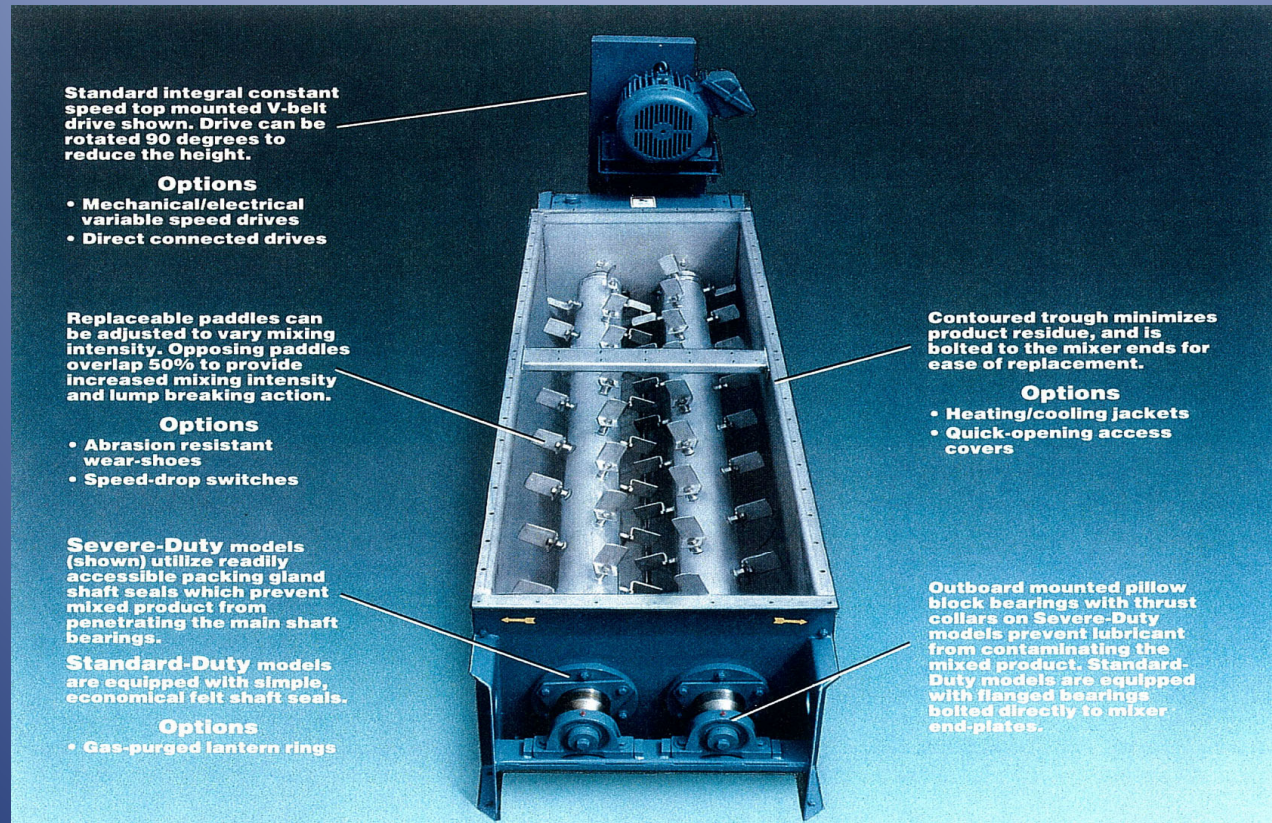


R.L. STROUP CO. LTD.

Hammermill-Internal View



Double Agitator Mixer



Energy Management

Thermo Dynamics teaches: Energy can neither be created or destroyed.

Plant Operations teaches: Energy can neither be created or destroyed.

Just Lost

Willits, 2009

Pila in area tua est